

KVG 29

Cone cable gland, polyamide, Pg 29, RAL 7035

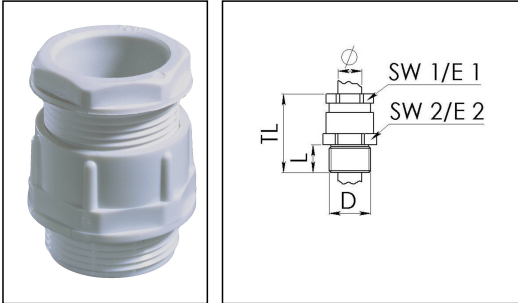

Product illustrations are exemplary and may differ from the chosen product. Further variants and individual customization, we will gladly provide you on request.



Material cable gland	Polyamide, fibre reinforced
Temp. range min	-20 °C
Temp. range max	80 °C
Protection class	IP54
Thread type	PG
Ø Connection thread D	29
Length screw-in thread L	11 mm
Ø cable diameter min	18 mm
Ø cable diameter max	25 mm
Key width SW1	40 mm
Key width SW2	42 mm
Collar diameter E1	43 mm
Collar diameter E2	45 mm
Total length TL	44 mm
Product Color	RAL 7035
Order no. RAL 7035	10060147
Type	KVG 29
Packing unit	20
ETIM-Classification	EC000441

Recommended accessories

MUG 29	10060676
ADR 29	10061425

Your Contact:

WISKA Hoppmann GmbH

Kisdorfer Weg 28 · 24568 Kaltenkirchen · Germany

☎ +49-4191-508-0 · 📠 +49-4191-508-209

contact@wiska.de · www.wiska.com

14.11.2018

Your Contact:

WISKA Hoppmann GmbH

Kisdorfer Weg 28 · 24568 Kaltenkirchen · Germany

☎ +49-4191-508-0 · 📠 +49-4191-508-209

contact@wiska.de · www.wiska.com

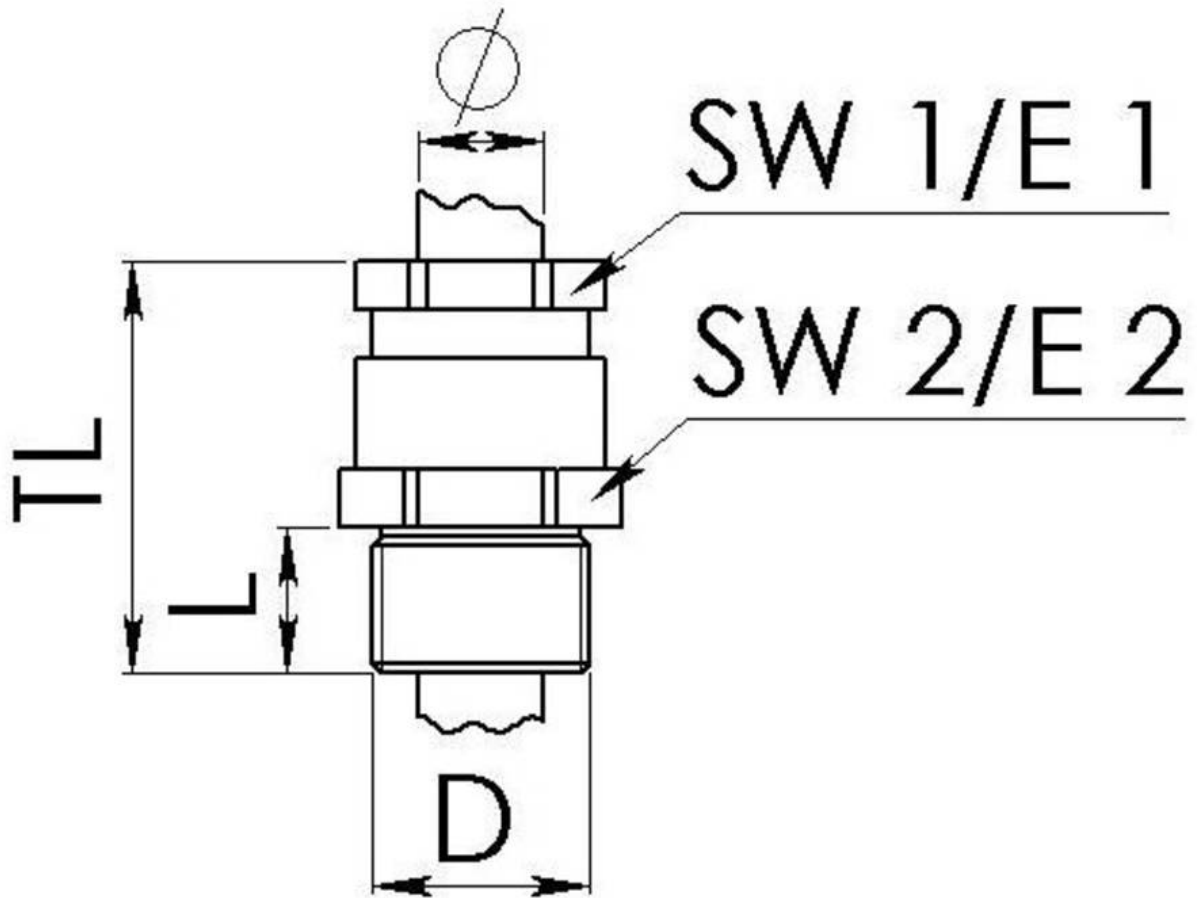

Your Contact:

WISKA Hoppmann GmbH

Kisdorfer Weg 28 · 24568 Kaltenkirchen · Germany

☎ +49-4191-508-0 · 📠 +49-4191-508-209

contact@wiska.de · www.wiska.com