

KVG 42

Cone cable gland, polyamide, Pg 42, RAL 7035

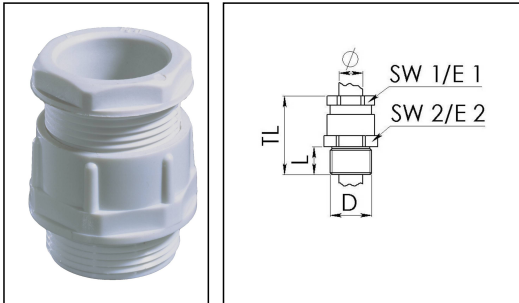

Product illustrations are exemplary and may differ from the chosen product. Further variants and individual customization, we will gladly provide you on request.



Material cable gland	Polyamide, fibre reinforced
Temp. range min	-20 °C
Temp. range max	80 °C
Protection class	IP54
Thread type	PG
Ø Connection thread D	42
Length screw-in thread L	13 mm
Ø cable diameter min	30 mm
Ø cable diameter max	38 mm
Key width SW1	55 mm
Key width SW2	60 mm
Collar diameter E1	59 mm
Collar diameter E2	66 mm
Total length TL	57 mm
Product Color	RAL 7035
Order no. RAL 7035	10060149
Type	KVG 42
Packing unit	10
ETIM-Classification	EC000441

Recommended accessories

MUG 42	10060678
ADR 42	10061427

Your Contact:

WISKA Hoppmann GmbH

Kisdorfer Weg 28 · 24568 Kaltenkirchen · Germany

☎ +49-4191-508-0 · 📠 +49-4191-508-209

contact@wiska.de · www.wiska.com

14.11.2018

Your Contact:

WISKA Hoppmann GmbH

Kisdorfer Weg 28 · 24568 Kaltenkirchen · Germany

☎ +49-4191-508-0 · 📠 +49-4191-508-209

contact@wiska.de · www.wiska.com

