

KVG 48

Cone cable gland, polyamide, Pg 48, RAL 7035

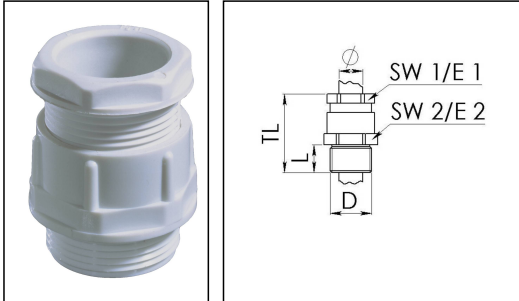

Product illustrations are exemplary and may differ from the chosen product. Further variants and individual customization, we will gladly provide you on request.



Material cable gland	Polyamide, fibre reinforced
Temp. range min	-20 °C
Temp. range max	80 °C
Protection class	IP54
Thread type	PG
Ø Connection thread D	48
Length screw-in thread L	15 mm
Ø cable diameter min	38 mm
Ø cable diameter max	44 mm
Key width SW1	60 mm
Key width SW2	65 mm
Collar diameter E1	65 mm
Collar diameter E2	69 mm
Total length TL	60 mm
Product Color	RAL 7035
Order no. RAL 7035	10060150
Type	KVG 48
Packing unit	5
ETIM-Classification	EC000441

Recommended accessories

MUG 48	10060679
ADR 48	10061428

Your Contact:

WISKA Hoppmann GmbH

Kisdorfer Weg 28 · 24568 Kaltenkirchen · Germany

☎ +49-4191-508-0 · 📠 +49-4191-508-209

contact@wiska.de · www.wiska.com

18.08.2018

Your Contact:

WISKA Hoppmann GmbH

Kisdorfer Weg 28 · 24568 Kaltenkirchen · Germany

☎ +49-4191-508-0 · 📠 +49-4191-508-209

contact@wiska.de · www.wiska.com

