

## ESKVS 16

Cable gland with bend protection, polyamide

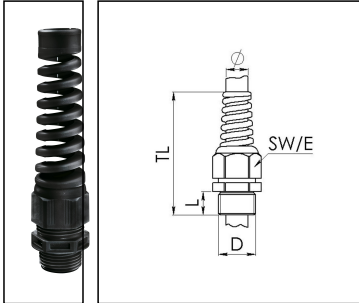

Product illustrations are exemplary and may differ from the chosen product. Further variants and individual customization, we will gladly provide you on request.



Material cable gland	Polyamide
Material sealing gasket	EPDM
Protection class	IP69, IP68 (5 bar 30 min)
Temp. range min	-40 °C
Temp. range max	100 °C
Glow wire test	750 °C
Thread type	M
Ø Connection thread D	16
Lead	1,5
Length screw-in thread L	9 mm
Ø cable diameter min	4,5 mm
Ø cable diameter max	10 mm
Ø cable diameter UL	6 mm - 8,6 mm
Key width SW	20 mm
Collar diameter (E)	22 mm
Total length TL	82 mm - 88 mm
Type of cable anchorage	A
Install. torques fitting	3,5 N m
Install. torques cap nut	3 N m
Impact category	3
Product Color	RAL 9005
Type	ESKVS 16
Order no. RAL 9005	10061277
Packing unit	100
ETIM-Classification	EC000441

Recommended accessories

<b>EMUG 16</b>	10061781
<b>RDE 16</b>	10062184
<b>EADR 16</b>	10062802
<b>BS 10</b>	10064008
<b>MFD 16/02/040</b>	10064393
<b>MFD 16/03/021</b>	10101014

28.06.2017

