

ESKVZ-L 25

Cable gland long with external strain relief, polyamide, M25, RAL 9005

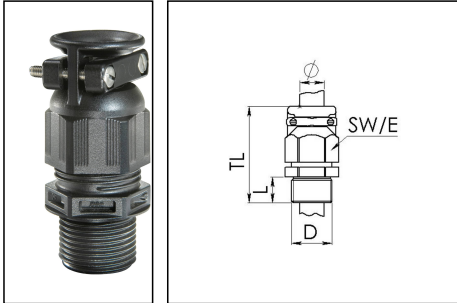

Product illustrations are exemplary and may differ from the chosen product. Further variants and individual customization, we will gladly provide you on request.



Material cable gland	Polyamide
Material sealing gasket	EPDM
Protection class	IP69, IP68 (5 bar 30 min)
Temp. range min	-40 °C
Temp. range max	100 °C
Glow wire test	750 °C
Thread type	M
Ø Connection thread D	25
Lead	1,5
Length screw-in thread L	15 mm
Ø cable diameter min	9 mm
Ø cable diameter max	17 mm
Ø cable diameter UL	10,8 mm - 15,8 mm
Key width SW	29 mm
Collar diameter (E)	32 mm
Total length TL	56 mm - 65 mm
Type of cable anchorage	B
Install. torques fitting	10 N m
Install. torques cap nut	4 N m
Impact category	4
Torque clamp srew	0,4 N m
Product Color	RAL 9005
Type	ESKVZ-L 25
Order no. RAL 9005	10061473
Packing unit	25

Your Contact:

WISKA Hoppmann GmbH

Kisdorfer Weg 28 · 24568 Kaltenkirchen · Germany

☎ +49-4191-508-0 · 📠 +49-4191-508-209

contact@wiska.de · www.wiska.com

Recommended accessories

RDE 25	10060768
EMUG 25	10061783
EADR 25	10062804
BS 17	10064012

19.11.2018

Your Contact:

WISKA Hoppmann GmbH

Kisdorfer Weg 28 · 24568 Kaltenkirchen · Germany

 +49-4191-508-0 ·  +49-4191-508-209

contact@wiska.de · www.wiska.com



Your Contact:

WISKA Hoppmann GmbH

Kisdorfer Weg 28 · 24568 Kaltenkirchen · Germany

☎ +49-4191-508-0 · 📠 +49-4191-508-209

contact@wiska.de · www.wiska.com