

NSKV 3/4 LT

Cable gland LowTemp, polyamide, NPT 3/4", RAL 7035

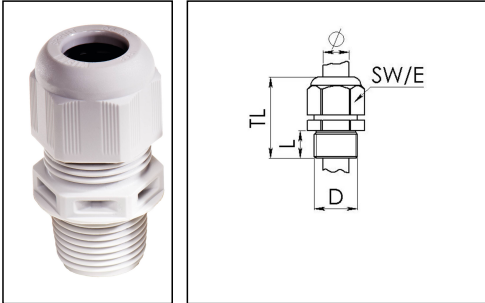

Product illustrations are exemplary and may differ from the chosen product. Further variants and individual customization, we will gladly provide you on request.



Material cable gland	Polyamide
Material sealing gasket	Silicone
Temp. range min	-60 °C
Temp. range max	100 °C
Protection class	IP69, IP68 (5 bar 30 min)
Thread type	NPT
Ø Connection thread D	3/4"
Length screw-in thread L	15 mm
Ø cable diameter min	9 mm
Ø cable diameter max	17 mm
Key width SW	29 mm
Collar diameter (E)	32 mm
Total length TL	44 mm - 53 mm
Glow wire test	750 °C
Type of cable anchorage	A
Install. torques fitting	10 N m
Install. torques cap nut	4 N m
Product Color	RAL 7035
Order no. RAL 7035	10061870
Type	NSKV 3/4 LT
Packing unit	50

Recommended accessories

Your Contact:

WISKA Hoppmann GmbH
Kisdorfer Weg 28 · 24568 Kaltenkirchen · Germany
☎ +49-4191-508-0 · 📠 +49-4191-508-209
contact@wiska.de · www.wiska.com

RDE 25 LT	10063910
BS 17	10064012
EADR 25/90 LT	10105707

17.11.2018

Your Contact:

WISKA Hoppmann GmbH

Kisdorfer Weg 28 · 24568 Kaltenkirchen · Germany

☎ +49-4191-508-0 · 📠 +49-4191-508-209

contact@wiska.de · www.wiska.com



Your Contact:

WISKA Hoppmann GmbH

Kisdorfer Weg 28 · 24568 Kaltenkirchen · Germany

☎ +49-4191-508-0 · 📠 +49-4191-508-209

contact@wiska.de · www.wiska.com