

SMKV 42

Cable gland hexagonal, brass nickel-plated, Pg 42, with short thread

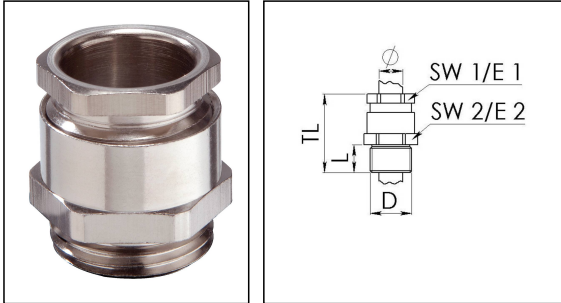

Product illustrations are exemplary and may differ from the chosen product. Further variants and individual customization, we will gladly provide you on request.



Material cable gland	Brass nickel-plated
Material sealing gasket	Soft rubber
Temp. range min	-40 °C
Temp. range max	70 °C
Protection class	IP54
Thread type	PG
Ø Connection thread D	42
Length screw-in thread L	10 mm
Ø cable diameter min	29 mm
Ø cable diameter max	40 mm
Key width SW1	54 mm
Key width SW2	57 mm
Collar diameter E1	59 mm
Collar diameter E2	63 mm
Total length TL	44 mm
Impact category	6
Surface	Nickel-plated
Order no. nickel-plated	10062089
Type	SMKV 42
Packing unit	10
ETIM-Classification	EC000441

Recommended accessories

Your Contact:

WISKA Hoppmann GmbH

Kisdorfer Weg 28 · 24568 Kaltenkirchen · Germany

☎ +49-4191-508-0 · 📠 +49-4191-508-209

contact@wiska.de · www.wiska.com

21.11.2018

Your Contact:

WISKA Hoppmann GmbH

Kisdorfer Weg 28 · 24568 Kaltenkirchen · Germany

☎ +49-4191-508-0 · 📠 +49-4191-508-209

contact@wiska.de · www.wiska.com



Your Contact:

WISKA Hoppmann GmbH

Kisdorfer Weg 28 · 24568 Kaltenkirchen · Germany

☎ +49-4191-508-0 · 📠 +49-4191-508-209

contact@wiska.de · www.wiska.com