

SKMKV 9

Cable gland hexagonal, brass nickel-plated, Pg 9 with external strain relief

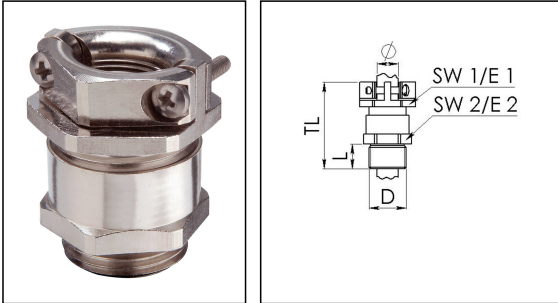

Product illustrations are exemplary and may differ from the chosen product. Further variants and individual customization, we will gladly provide you on request.



Material cable gland	Brass nickel-plated
Material sealing gasket	Soft rubber
Temp. range min	-40 °C
Temp. range max	70 °C
Protection class	IP54
Thread type	PG
Ø Connection thread D	9
Length screw-in thread L	6 mm
Ø cable diameter min	4 mm
Ø cable diameter max	11 mm
Key width SW1	19 mm
Key width SW2	17 mm
Collar diameter E1	21 mm
Collar diameter E2	19 mm
Total length TL	29 mm
Impact category	6
Surface	Nickel-plated
Order no. nickel-plated	10062132
Type	SKMKV 9
Packing unit	50
ETIM-Classification	EC000441

Recommended accessories

Your Contact:

WISKA Hoppmann GmbH

Kisdorfer Weg 28 · 24568 Kaltenkirchen · Germany

☎ +49-4191-508-0 · 📠 +49-4191-508-209

contact@wiska.de · www.wiska.com

17.11.2018

Your Contact:

WISKA Hoppmann GmbH

Kisdorfer Weg 28 · 24568 Kaltenkirchen · Germany

☎ +49-4191-508-0 · 📠 +49-4191-508-209

contact@wiska.de · www.wiska.com



Your Contact:

WISKA Hoppmann GmbH

Kisdorfer Weg 28 · 24568 Kaltenkirchen · Germany

☎ +49-4191-508-0 · 📠 +49-4191-508-209

contact@wiska.de · www.wiska.com