

## SKMKV 42

Cable gland hexagonal, brass nickel-plated, Pg 42 with external strain relief

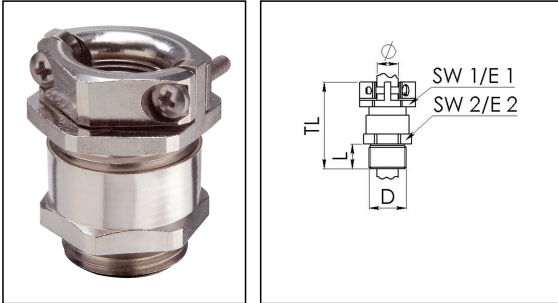

Product illustrations are exemplary and may differ from the chosen product. Further variants and individual customization, we will gladly provide you on request.



<b>Material cable gland</b>	Brass nickel-plated
<b>Material sealing gasket</b>	Soft rubber
<b>Temp. range min</b>	-40 °C
<b>Temp. range max</b>	70 °C
<b>Protection class</b>	IP54
<b>Thread type</b>	PG
<b>Ø Connection thread D</b>	42
<b>Length screw-in thread L</b>	10 mm
<b>Ø cable diameter min</b>	29 mm
<b>Ø cable diameter max</b>	40 mm
<b>Key width SW1</b>	59 mm
<b>Key width SW2</b>	57 mm
<b>Collar diameter E1</b>	65 mm
<b>Collar diameter E2</b>	63 mm
<b>Total length TL</b>	53 mm
<b>Impact category</b>	6
<b>Surface</b>	Nickel-plated
<b>Order no. nickel-plated</b>	10062139
<b>Type</b>	SKMKV 42
<b>Packing unit</b>	5
<b>ETIM-Classification</b>	EC000441

Recommended accessories

Your Contact:

**WISKA Hoppmann GmbH**

Kisdorfer Weg 28 · 24568 Kaltenkirchen · Germany

☎ +49-4191-508-0 · 📠 +49-4191-508-209



contact@wiska.de · www.wiska.com

18.11.2018

Your Contact:

**WISKA Hoppmann GmbH**

Kisdorfer Weg 28 · 24568 Kaltenkirchen · Germany

 +49-4191-508-0 ·  +49-4191-508-209

[contact@wiska.de](mailto:contact@wiska.de) · [www.wiska.com](http://www.wiska.com)

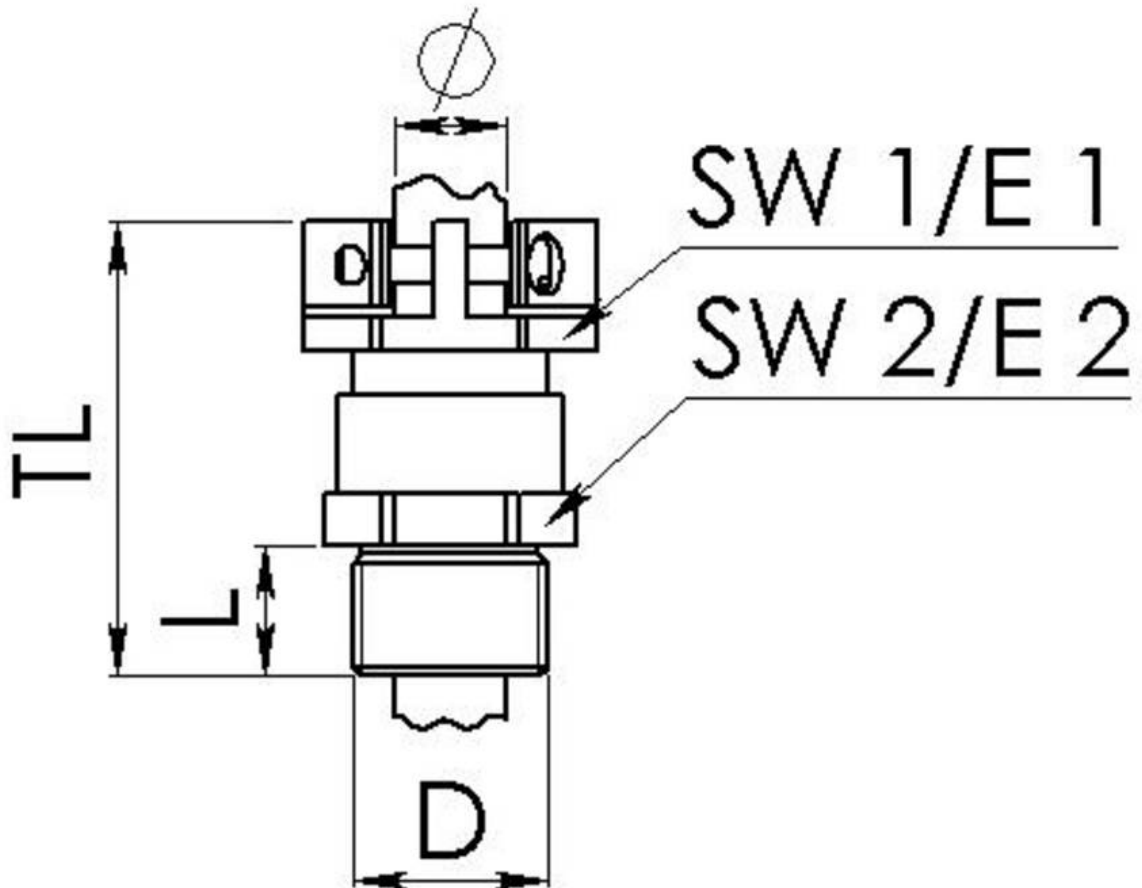

Your Contact:

**WISKA Hoppmann GmbH**

Kisdorfer Weg 28 · 24568 Kaltenkirchen · Germany

☎ +49-4191-508-0 · 📠 +49-4191-508-209

contact@wiska.de · www.wiska.com