

SKMKV 48

Cable gland hexagonal, brass nickel-plated, Pg 48 with external strain relief

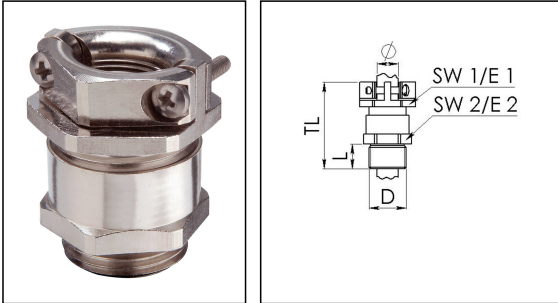

Product illustrations are exemplary and may differ from the chosen product. Further variants and individual customization, we will gladly provide you on request.



Material cable gland	Brass nickel-plated
Material sealing gasket	Soft rubber
Temp. range min	-40 °C
Temp. range max	70 °C
Protection class	IP54
Thread type	PG
Ø Connection thread D	48
Length screw-in thread L	10 mm
Ø cable diameter min	35 mm
Ø cable diameter max	46 mm
Key width SW1	64 mm
Key width SW2	64 mm
Collar diameter E1	70 mm
Collar diameter E2	70 mm
Total length TL	53 mm
Impact category	6
Surface	Nickel-plated
Order no. nickel-plated	10062140
Type	SKMKV 48
Packing unit	5
ETIM-Classification	EC000441

Recommended accessories

Your Contact:

WISKA Hoppmann GmbH

Kisdorfer Weg 28 · 24568 Kaltenkirchen · Germany

☎ +49-4191-508-0 · 📠 +49-4191-508-209

contact@wiska.de · www.wiska.com

17.12.2018

Your Contact:

WISKA Hoppmann GmbH

Kisdorfer Weg 28 · 24568 Kaltenkirchen · Germany

☎ +49-4191-508-0 · 📠 +49-4191-508-209

contact@wiska.de · www.wiska.com



Your Contact:

WISKA Hoppmann GmbH

Kisdorfer Weg 28 · 24568 Kaltenkirchen · Germany

☎ +49-4191-508-0 · 📠 +49-4191-508-209

contact@wiska.de · www.wiska.com