

## MSKV 11

Cable gland, brass nickel-plated, Pg 11

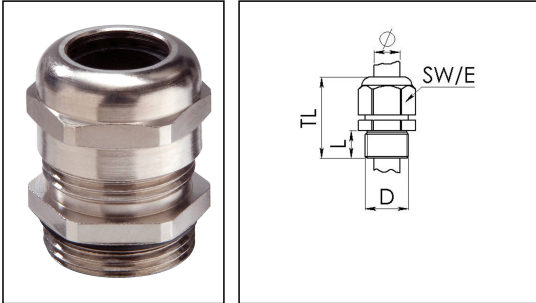

Product illustrations are exemplary and may differ from the chosen product. Further variants and individual customization, we will gladly provide you on request.



<b>Material cable gland</b>	Brass nickel-plated
<b>Material clamping cage</b>	Polyamide
<b>Material sealing gasket</b>	TPV
<b>Temp. range min</b>	-40 °C
<b>Temp. range max</b>	100 °C
<b>Protection class</b>	IP69, IP68 (5 bar 30 min)
<b>Thread type</b>	PG
<b>Ø Connection thread D</b>	11
<b>Length screw-in thread L</b>	6 mm
<b>Ø cable diameter min</b>	5 mm
<b>Ø cable diameter max</b>	10 mm
<b>Key width SW</b>	20 mm
<b>Collar diameter (E)</b>	22 mm
<b>Total length TL</b>	22 mm - 27 mm
<b>Install. torques fitting</b>	15 N m
<b>Install. torques cap nut</b>	9 N m
<b>Impact category</b>	6
<b>Surface</b>	Nickel-plated
<b>Order no. nickel-plated</b>	10062283
<b>Type</b>	MSKV 11
<b>Packing unit</b>	50
<b>ETIM-Classification</b>	EC000441

Your Contact:

WISKA Hoppmann GmbH

Kisdorfer Weg 28 · 24568 Kaltenkirchen · Germany

☎ +49-4191-508-0 · 📠 +49-4191-508-209

contact@wiska.de · www.wiska.com

Recommended accessories

**MMU 11**

10062143

15.08.2018

Your Contact:

**WISKA Hoppmann GmbH**

Kisdorfer Weg 28 · 24568 Kaltenkirchen · Germany

 +49-4191-508-0 ·  +49-4191-508-209

[contact@wiska.de](mailto:contact@wiska.de) · [www.wiska.com](http://www.wiska.com)



Your Contact:

**WISKA Hoppmann GmbH**

Kisdorfer Weg 28 · 24568 Kaltenkirchen · Germany

☎ +49-4191-508-0 · 📠 +49-4191-508-209

contact@wiska.de · www.wiska.com