

## ESMKV-L 32

Cable gland hexagonal, brass nickel-plated, M32, with long thread

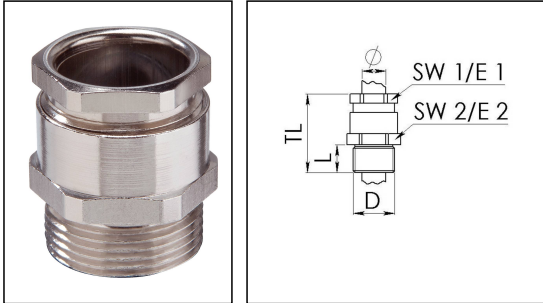

Product illustrations are exemplary and may differ from the chosen product. Further variants and individual customization, we will gladly provide you on request.



<b>Material cable gland</b>	Brass nickel-plated
<b>Material sealing gasket</b>	Soft rubber
<b>Temp. range min</b>	-30 °C
<b>Temp. range max</b>	80 °C
<b>Protection class</b>	IP54
<b>Thread type</b>	M
<b>Ø Connection thread D</b>	32
<b>Lead</b>	1,5
<b>Length screw-in thread L</b>	13 mm
<b>Ø cable diameter min</b>	15 mm
<b>Ø cable diameter max</b>	26 mm
<b>Key width SW1</b>	32 mm
<b>Key width SW2</b>	34 mm
<b>Collar diameter E1</b>	35 mm
<b>Collar diameter E2</b>	38 mm
<b>Total length TL</b>	37 mm
<b>Impact category</b>	6
<b>Surface</b>	Nickel-plated
<b>Order no. nickel-plated</b>	10062884
<b>Type</b>	ESMKV-L 32
<b>Packing unit</b>	25
<b>ETIM-Classification</b>	EC000441

Your Contact:

**WISKA Hoppmann GmbH**

Kisdorfer Weg 28 · 24568 Kaltenkirchen · Germany

☎ +49-4191-508-0 · 📠 +49-4191-508-209

contact@wiska.de · www.wiska.com

Recommended accessories

<b>EMMU 32</b>	10063145
<b>ORD-E 32</b>	10064701

17.12.2018

Your Contact:

**WISKA Hoppmann GmbH**

Kisdorfer Weg 28 · 24568 Kaltenkirchen · Germany

☎ +49-4191-508-0 · 📠 +49-4191-508-209

contact@wiska.de · www.wiska.com

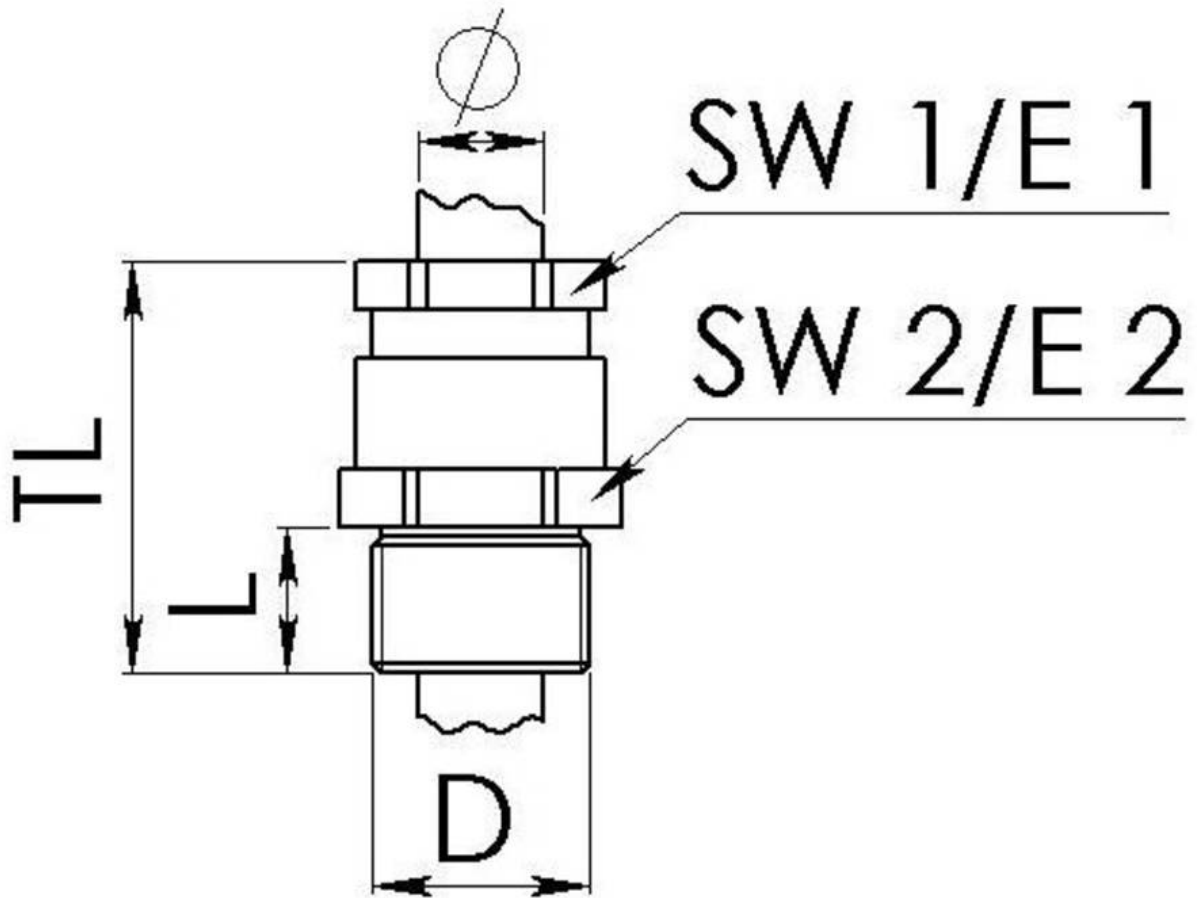

Your Contact:

**WISKA Hoppmann GmbH**

Kisdorfer Weg 28 · 24568 Kaltenkirchen · Germany

☎ +49-4191-508-0 · 📠 +49-4191-508-209

contact@wiska.de · www.wiska.com