

ESKMKV 40

Cable gland hexagonal, brass nickel-plated, M40, external strain relief

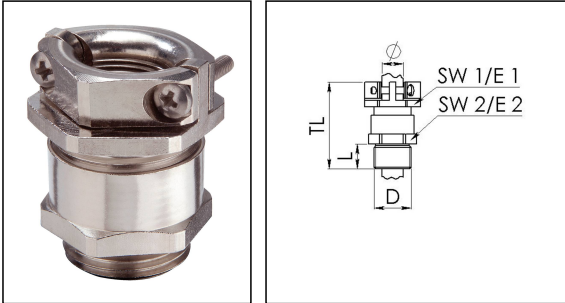

Product illustrations are exemplary and may differ from the chosen product. Further variants and individual customization, we will gladly provide you on request.



Material cable gland	Brass nickel-plated
Material sealing gasket	Soft rubber
Temp. range min	-30 °C
Temp. range max	80 °C
Protection class	IP54
Thread type	M
Ø Connection thread D	40
Lead	1,5
Length screw-in thread L	8 mm
Ø cable diameter min	23 mm
Ø cable diameter max	34 mm
Key width SW1	52 mm
Key width SW2	50 mm
Collar diameter E1	56 mm
Collar diameter E2	54 mm
Total length TL	48 mm
Impact category	6
Surface	Nickel-plated
Order no. nickel-plated	10063137
Type	ESKMKV 40
Packing unit	10
ETIM-Classification	EC000441

Your Contact:

WISKA Hoppmann GmbH

Kisdorfer Weg 28 · 24568 Kaltenkirchen · Germany

☎ +49-4191-508-0 · 📠 +49-4191-508-209

contact@wiska.de · www.wiska.com

Recommended accessories

EMMU 40	10063146
ORD-E 40	10064702

20.08.2018

Your Contact:

WISKA Hoppmann GmbH

Kisdorfer Weg 28 · 24568 Kaltenkirchen · Germany

☎ +49-4191-508-0 · 📠 +49-4191-508-209

contact@wiska.de · www.wiska.com



Your Contact:

WISKA Hoppmann GmbH

Kisdorfer Weg 28 · 24568 Kaltenkirchen · Germany

☎ +49-4191-508-0 · 📠 +49-4191-508-209

contact@wiska.de · www.wiska.com