

ESKMKV 63

Cable gland hexagonal, brass nickel-plated, M63, external strain relief

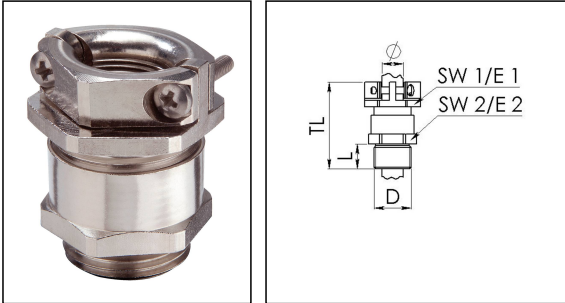

Product illustrations are exemplary and may differ from the chosen product. Further variants and individual customization, we will gladly provide you on request.



Material cable gland	Brass nickel-plated
Material sealing gasket	Soft rubber
Temp. range min	-30 °C
Temp. range max	80 °C
Protection class	IP54
Thread type	M
Ø Connection thread D	63
Lead	1,5
Length screw-in thread L	10 mm
Ø cable diameter min	35 mm
Ø cable diameter max	46 mm
Key width SW1	64 mm
Key width SW2	66 mm
Collar diameter E1	70 mm
Collar diameter E2	70 mm
Total length TL	53 mm
Impact category	6
Surface	Nickel-plated
Order no. nickel-plated	10063139
Type	ESKMKV 63
Packing unit	5
ETIM-Classification	EC000441

Your Contact:

WISKA Hoppmann GmbH

Kisdorfer Weg 28 · 24568 Kaltenkirchen · Germany

☎ +49-4191-508-0 · 📠 +49-4191-508-209

contact@wiska.de · www.wiska.com

Recommended accessories

EMMU 63	10063148
ORD-E 63	10064704

22.09.2018

Your Contact:

WISKA Hoppmann GmbH

Kisdorfer Weg 28 · 24568 Kaltenkirchen · Germany

☎ +49-4191-508-0 · 📠 +49-4191-508-209

contact@wiska.de · www.wiska.com



Your Contact:

WISKA Hoppmann GmbH

Kisdorfer Weg 28 · 24568 Kaltenkirchen · Germany

☎ +49-4191-508-0 · 📠 +49-4191-508-209

contact@wiska.de · www.wiska.com