

## WISKONUS-SET 20

Cable gland, polyamide, M20, RAL 7035, with locknut

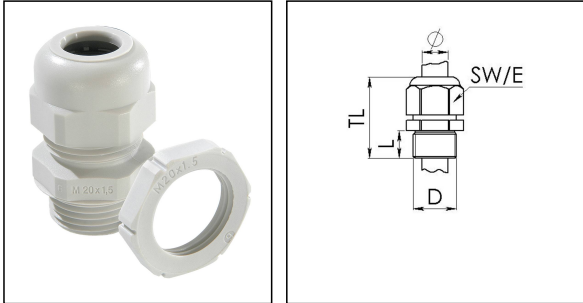

Product illustrations are exemplary and may differ from the chosen product. Further variants and individual customization, we will gladly provide you on request.



<b>Material cable gland</b>	Polyamide
<b>Material sealing gasket</b>	EPDM
<b>Temp. range min</b>	-20 °C
<b>Temp. range max</b>	80 °C
<b>Protection class</b>	IP66
<b>Thread type</b>	M
<b>Ø Connection thread D</b>	20
<b>Lead</b>	1,5
<b>Length screw-in thread L</b>	10 mm
<b>Ø cable diameter min</b>	7 mm
<b>Ø cable diameter max</b>	12 mm
<b>Key width SW</b>	24 mm
<b>Collar diameter (E)</b>	26 mm
<b>Total length TL</b>	35 mm - 41 mm
<b>Type of cable anchorage</b>	A
<b>Product Color</b>	RAL 7035
<b>Order no. RAL 7035</b>	10063251
<b>Type</b>	WISKONUS-SET 20
<b>Packing unit</b>	50
<b>ETIM-Classification</b>	EC000441

Recommended accessories

<b>EADR 20</b>	10062803
----------------	----------

Your Contact:

**WISKA Hoppmann GmbH**

Kisdorfer Weg 28 · 24568 Kaltenkirchen · Germany

☎ +49-4191-508-0 · 📠 +49-4191-508-209



contact@wiska.de · www.wiska.com

14.11.2018

Your Contact:

**WISKA Hoppmann GmbH**

Kisdorfer Weg 28 · 24568 Kaltenkirchen · Germany

 +49-4191-508-0 ·  +49-4191-508-209

[contact@wiska.de](mailto:contact@wiska.de) · [www.wiska.com](http://www.wiska.com)



Your Contact:

**WISKA Hoppmann GmbH**

Kisdorfer Weg 28 · 24568 Kaltenkirchen · Germany

☎ +49-4191-508-0 · 📠 +49-4191-508-209

contact@wiska.de · www.wiska.com