

WISKONUS-SET 50

Cable gland, polyamide, M50, RAL 7035, with locknut

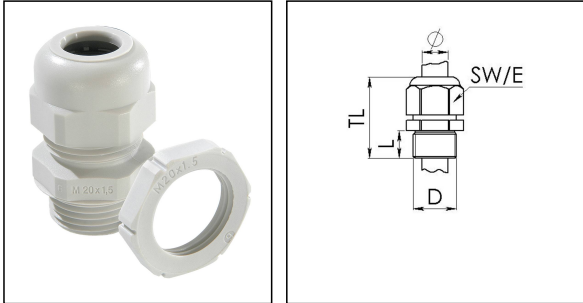

Product illustrations are exemplary and may differ from the chosen product. Further variants and individual customization, we will gladly provide you on request.



Material cable gland	Polyamide
Material sealing gasket	EPDM
Temp. range min	-20 °C
Temp. range max	80 °C
Protection class	IP66
Thread type	M
Ø Connection thread D	50
Lead	1,5
Length screw-in thread L	14 mm
Ø cable diameter min	23 mm
Ø cable diameter max	32 mm
Key width SW	53 mm
Collar diameter (E)	59 mm
Total length TL	56 mm - 65 mm
Type of cable anchorage	A
Product Color	RAL 7035
Order no. RAL 7035	10063255
Type	WISKONUS-SET 50
Packing unit	4
ETIM-Classification	EC000441

Recommended accessories

EADR 50	10062807
----------------	----------

Your Contact:

WISKA Hoppmann GmbH

Kisdorfer Weg 28 · 24568 Kaltenkirchen · Germany

☎ +49-4191-508-0 · 📠 +49-4191-508-209

contact@wiska.de · www.wiska.com

15.08.2018

Your Contact:

WISKA Hoppmann GmbH

Kisdorfer Weg 28 · 24568 Kaltenkirchen · Germany

☎ +49-4191-508-0 · 📠 +49-4191-508-209

contact@wiska.de · www.wiska.com



Your Contact:

WISKA Hoppmann GmbH

Kisdorfer Weg 28 · 24568 Kaltenkirchen · Germany

☎ +49-4191-508-0 · 📠 +49-4191-508-209

contact@wiska.de · www.wiska.com