

WISKONUS 16

Cable gland, polyamide, M16, RAL 7035

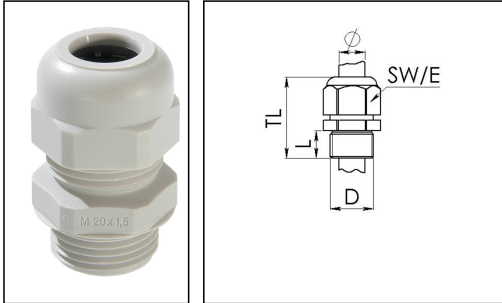

Product illustrations are exemplary and may differ from the chosen product. Further variants and individual customization, we will gladly provide you on request.



Material cable gland	Polyamide
Material sealing gasket	EPDM
Temp. range min	-20 °C
Temp. range max	80 °C
Protection class	IP66
Thread type	M
Ø Connection thread D	16
Lead	1,5
Length screw-in thread L	9 mm
Ø cable diameter min	5 mm
Ø cable diameter max	8 mm
Key width SW	19 mm
Collar diameter (E)	21 mm
Total length TL	32 mm - 36 mm
Product Color	RAL 7035
Order no. RAL 7035	10063258
Type	WISKONUS 16
Packing unit	50
ETIM-Classification	EC000441

Recommended accessories

EMUG 16	10060771
EADR 16	10062802

Your Contact:

WISKA Hoppmann GmbH
Kisdorfer Weg 28 · 24568 Kaltenkirchen · Germany
☎ +49-4191-508-0 · 📠 +49-4191-508-209
contact@wiska.de · www.wiska.com

17.11.2018

Your Contact:

WISKA Hoppmann GmbH

Kisdorfer Weg 28 · 24568 Kaltenkirchen · Germany

☎ +49-4191-508-0 · 📠 +49-4191-508-209

contact@wiska.de · www.wiska.com



Your Contact:

WISKA Hoppmann GmbH

Kisdorfer Weg 28 · 24568 Kaltenkirchen · Germany

☎ +49-4191-508-0 · 📠 +49-4191-508-209

contact@wiska.de · www.wiska.com