

WISKONUS 63

Cable gland, polyamide, M63, RAL 7035

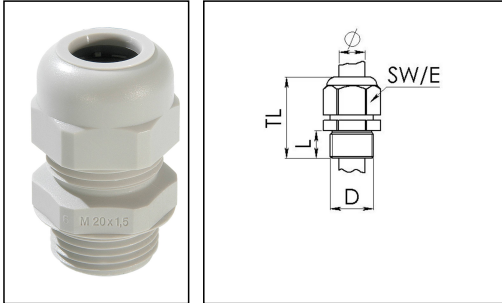

Product illustrations are exemplary and may differ from the chosen product. Further variants and individual customization, we will gladly provide you on request.



Material cable gland	Polyamide
Material sealing gasket	EPDM
Temp. range min	-20 °C
Temp. range max	80 °C
Protection class	IP66
Thread type	M
Ø Connection thread D	63
Lead	1,5
Length screw-in thread L	15 mm
Ø cable diameter min	37 mm
Ø cable diameter max	44 mm
Key width SW	65 mm
Collar diameter (E)	73 mm
Total length TL	60 mm - 68 mm
Product Color	RAL 7035
Order no. RAL 7035	10063264
Type	WISKONUS 63
Packing unit	3
ETIM-Classification	EC000441

Recommended accessories

EMUG 63	10060777
EADR 63	10062808

Your Contact:

WISKA Hoppmann GmbH

Kisdorfer Weg 28 · 24568 Kaltenkirchen · Germany

☎ +49-4191-508-0 · 📠 +49-4191-508-209



contact@wiska.de · www.wiska.com

17.11.2018

Your Contact:

WISKA Hoppmann GmbH

Kisdorfer Weg 28 · 24568 Kaltenkirchen · Germany

 +49-4191-508-0 ·  +49-4191-508-209

contact@wiska.de · www.wiska.com



Your Contact:

WISKA Hoppmann GmbH

Kisdorfer Weg 28 · 24568 Kaltenkirchen · Germany

☎ +49-4191-508-0 · 📠 +49-4191-508-209

contact@wiska.de · www.wiska.com