

ESKV-RDE 32

Cable gland with reduction sealing insert, polyamide, M32, RAL 7001

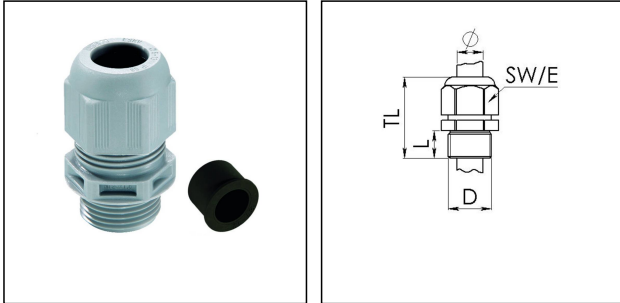

Product illustrations are exemplary and may differ from the chosen product. Further variants and individual customization, we will gladly provide you on request.



Material cable gland	Polyamide
Material sealing gasket	EPDM
Temp. range min	-40 °C
Temp. range max	100 °C
Protection class	IP69, IP68 (5 bar 30 min)
Thread type	M
Ø Connection thread D	32
Lead	1,5
Length screw-in thread L	12 mm
Ø cable diameter min	9 mm
Ø cable diameter max	21 mm
Key width SW	36 mm
Collar diameter (E)	40 mm
Total length TL	42 mm - 51 mm
Glow wire test	750 °C
Type of cable anchorage	A
Install. torques fitting	15 N m
Install. torques cap nut	4 N m
Impact category	4
Advice	With reduction insert
Product Color	RAL 7001
Order no. RAL 7001	10064988
Type	ESKV-RDE 32
Packing unit	25
ETIM-Classification	EC000441

Your Contact:

WISKA Hoppmann GmbH

Kisdorfer Weg 28 · 24568 Kaltenkirchen · Germany

☎ +49-4191-508-0 · 📠 +49-4191-508-209

contact@wiska.de · www.wiska.com

Recommended accessories

EMUG 32	10062716
EADR 32	10062805
BS 14	10064011

20.01.2019

Your Contact:

WISKA Hoppmann GmbH

Kisdorfer Weg 28 · 24568 Kaltenkirchen · Germany

☎ +49-4191-508-0 · 📠 +49-4191-508-209

contact@wiska.de · www.wiska.com



Your Contact:

WISKA Hoppmann GmbH

Kisdorfer Weg 28 · 24568 Kaltenkirchen · Germany

☎ +49-4191-508-0 · 📠 +49-4191-508-209

contact@wiska.de · www.wiska.com