

EMSKVZ 25

Cable gland, brass nickel-plated, M25, with external strain relief

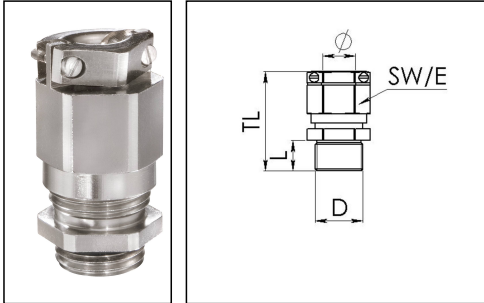

Product illustrations are exemplary and may differ from the chosen product. Further variants and individual customization, we will gladly provide you on request.



Material cable gland	Brass nickel-plated
Material clamping cage	Polyamide
Material sealing gasket	EPDM
Temp. range min	-40 °C
Temp. range max	100 °C
Protection class	IP69, IP68 (5 bar 30 min)
Thread type	M
Ø Connection thread D	25
Lead	1,5
Length screw-in thread L	7 mm
Ø cable diameter min	9 mm
Ø cable diameter max	17 mm
Ø cable diameter UL	7,5 mm - 11,3 mm
Key width SW	29 mm
Collar diameter (E)	32 mm
Total length TL	42 mm - 51 mm
Type of cable anchorage	B
Install. torques fitting	10 N m
Install. torques cap nut	10 N m
Impact category	6
Torque clamp srew	0,4 N m
Surface	Nickel-plated
Order no. nickel-plated	10065353
Packing unit	25
Type	EMSKVZ 25

Your Contact:

WISKA Hoppmann GmbH
Kisdorfer Weg 28 · 24568 Kaltenkirchen · Germany
☎ +49-4191-508-0 · 📠 +49-4191-508-209
contact@wiska.de · www.wiska.com

Recommended accessories

RDE 25	10060768
EMMU 25	10063144
BS 17	10064012

19.12.2018

Your Contact:

WISKA Hoppmann GmbH

Kisdorfer Weg 28 · 24568 Kaltenkirchen · Germany

☎ +49-4191-508-0 · 📠 +49-4191-508-209

contact@wiska.de · www.wiska.com

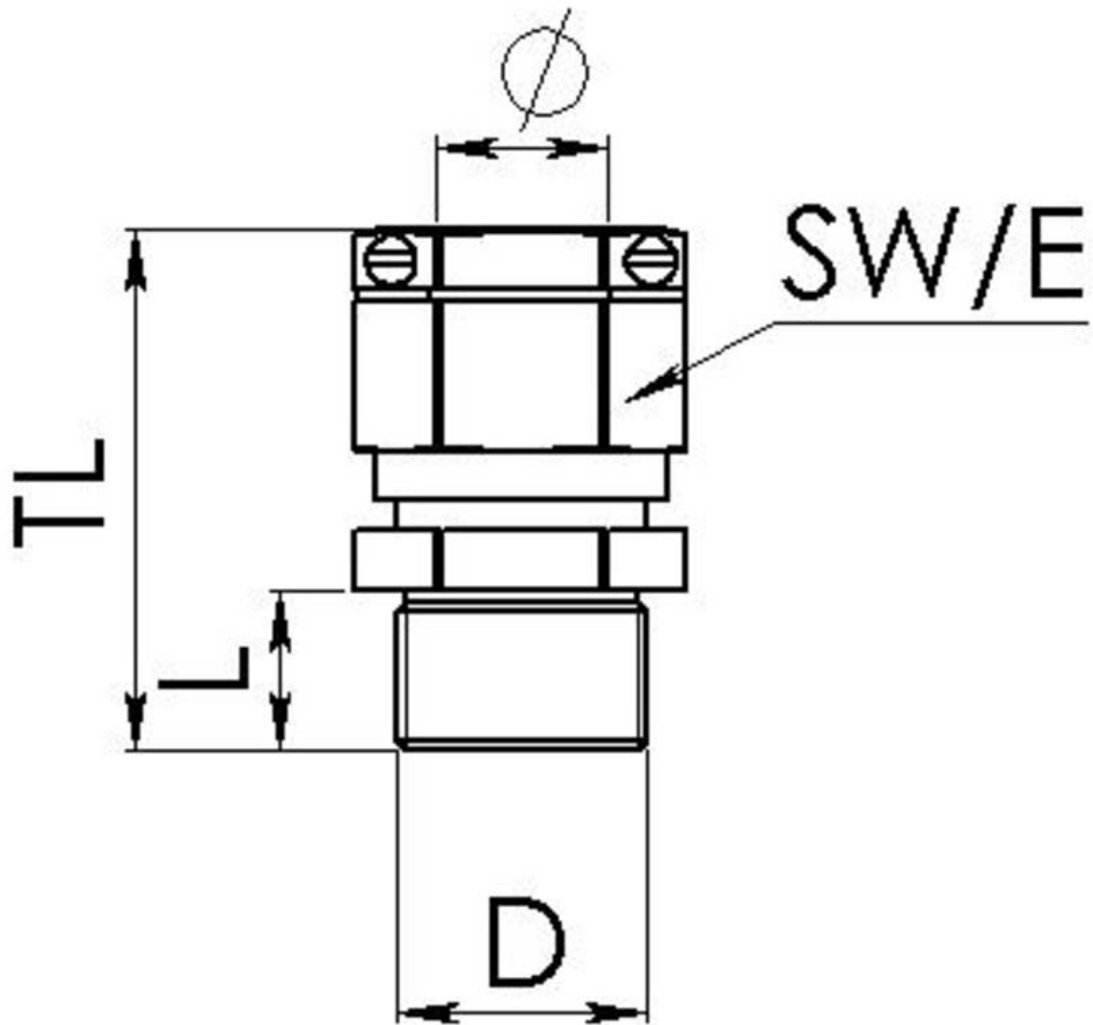

Your Contact:

WISKA Hoppmann GmbH

Kisdorfer Weg 28 · 24568 Kaltenkirchen · Germany

☎ +49-4191-508-0 · 📠 +49-4191-508-209

contact@wiska.de · www.wiska.com