

## EMSKVZ 40

Cable gland, brass nickel-plated, M40, with external strain relief

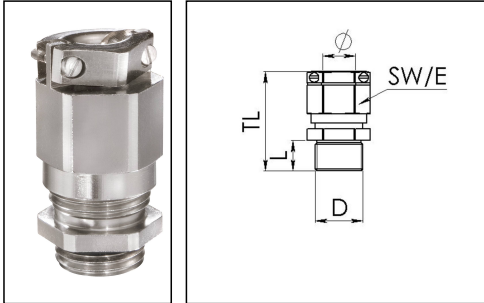

Product illustrations are exemplary and may differ from the chosen product. Further variants and individual customization, we will gladly provide you on request.



Material cable gland	Brass nickel-plated
Material clamping cage	Polyamide
Material sealing gasket	EPDM
Temp. range min	-40 °C
Temp. range max	100 °C
Protection class	IP69, IP68 (5 bar 30 min)
Thread type	M
Ø Connection thread D	40
Lead	1,5
Length screw-in thread L	8 mm
Ø cable diameter min	16 mm
Ø cable diameter max	28 mm
Ø cable diameter UL	17,4 mm - 26,4 mm
Key width SW	46 mm
Collar diameter (E)	51 mm
Total length TL	54 mm - 65 mm
Type of cable anchorage	B
Install. torques fitting	20 N m
Install. torques cap nut	20 N m
Impact category	6
Torque clamp srew	0,5 N m
Surface	Nickel-plated
Order no. nickel-plated	10065355
Packing unit	5
Type	EMSKVZ 40

Your Contact:

WISKA Hoppmann GmbH

Kisdorfer Weg 28 · 24568 Kaltenkirchen · Germany

☎ +49-4191-508-0 · 📠 +49-4191-508-209

contact@wiska.de · www.wiska.com

## Recommended accessories

<b>RDE 40</b>	10062187
<b>EMMU 40</b>	10063146
<b>BS 28</b>	10064016

17.08.2018

## Your Contact:

**WISKA Hoppmann GmbH**

Kisdorfer Weg 28 · 24568 Kaltenkirchen · Germany

☎ +49-4191-508-0 · 📠 +49-4191-508-209

contact@wiska.de · www.wiska.com

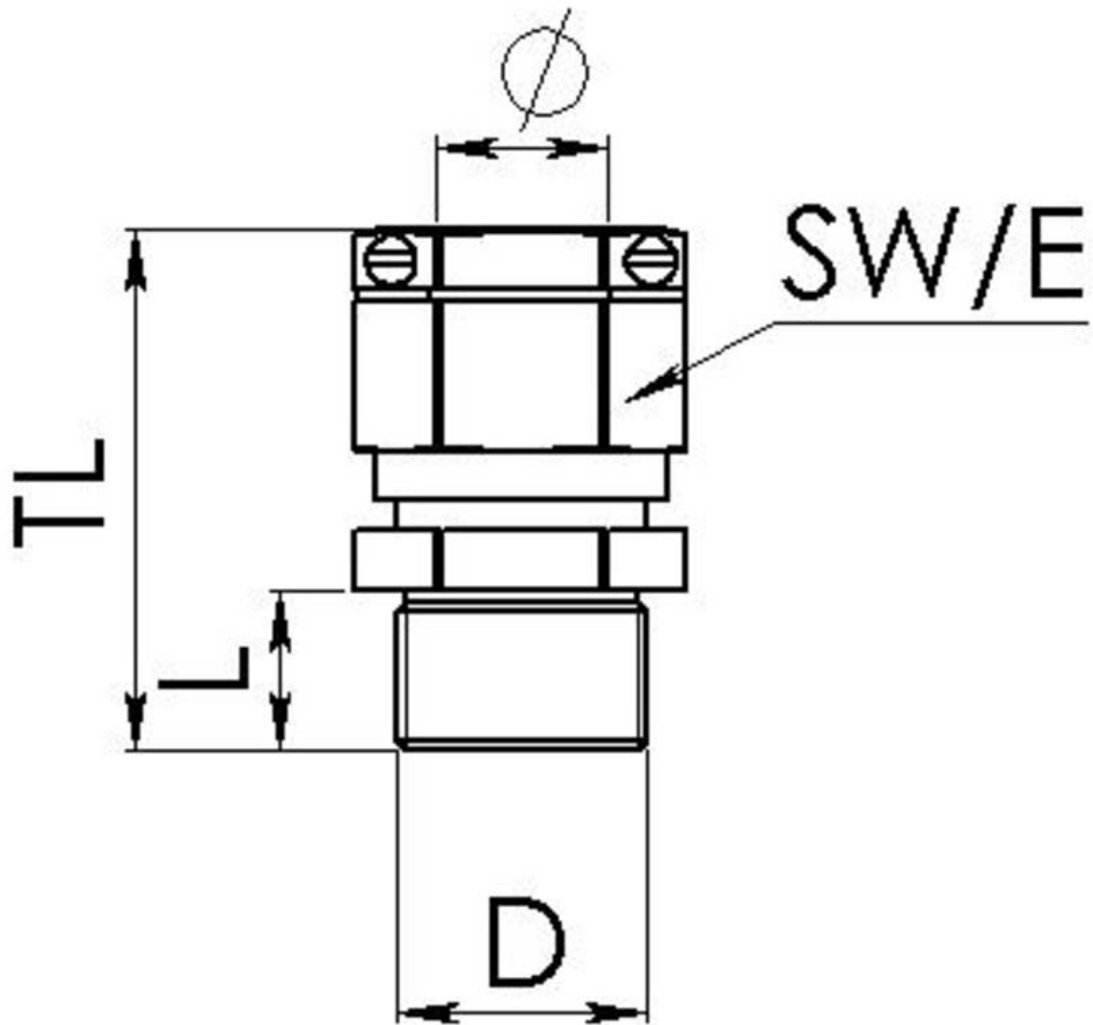

Your Contact:  
**WISKA Hoppmann GmbH**  
Kisdorfer Weg 28 · 24568 Kaltenkirchen · Germany  
☎ +49-4191-508-0 · 📠 +49-4191-508-209  
contact@wiska.de · www.wiska.com