

EMSKV-L 25 LT

Cable gland LowTemp, brass nickel-plated, M25, with long thread

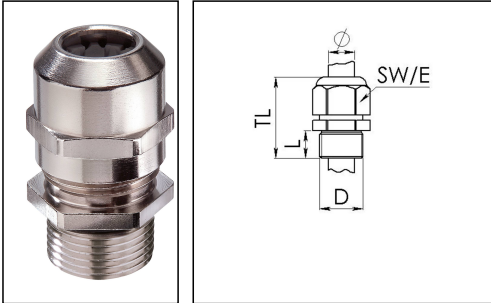

Product illustrations are exemplary and may differ from the chosen product. Further variants and individual customization, we will gladly provide you on request.



Material cable gland	Brass nickel-plated
Material clamping cage	Polyamide
Material sealing gasket	Silicone
Temp. range min	-60 °C
Temp. range max	100 °C
Protection class	IP69, IP68 (5 bar 30 min)
Thread type	M
Ø Connection thread D	25
Lead	1,5
Length screw-in thread L	12 mm
Ø cable diameter min	9 mm
Ø cable diameter max	17 mm
Key width SW	29 mm
Collar diameter (E)	32 mm
Total length TL	38 mm - 47 mm
Type of cable anchorage	A
Install. torques fitting	10 N m
Install. torques cap nut	15 N m
Impact category	6
Surface	Nickel-plated
Order no. nickel-plated	10065811
Packing unit	50
Type	EMSKV-L 25 LT
ETIM-Classification	EC000441

Your Contact:

WISKA Hoppmann GmbH

Kisdorfer Weg 28 · 24568 Kaltenkirchen · Germany

☎ +49-4191-508-0 · 📠 +49-4191-508-209

contact@wiska.de · www.wiska.com

Recommended accessories

EMMU 25	10063144
RDE 25 LT	10063910
BS 17	10064012

19.11.2018

Your Contact:

WISKA Hoppmann GmbH

Kisdorfer Weg 28 · 24568 Kaltenkirchen · Germany

☎ +49-4191-508-0 · 📠 +49-4191-508-209

contact@wiska.de · www.wiska.com



Your Contact:

WISKA Hoppmann GmbH

Kisdorfer Weg 28 · 24568 Kaltenkirchen · Germany

☎ +49-4191-508-0 · 📠 +49-4191-508-209

contact@wiska.de · www.wiska.com