

EMSKV-L 40 LT

Cable gland LowTemp, brass nickel-plated, M40, with long thread

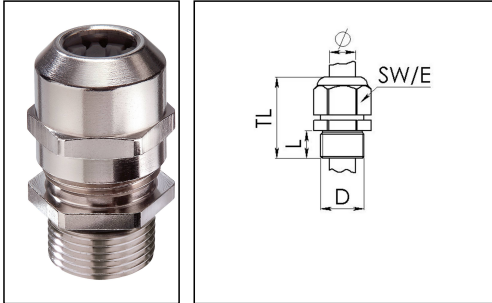

Product illustrations are exemplary and may differ from the chosen product. Further variants and individual customization, we will gladly provide you on request.



Material cable gland	Brass nickel-plated
Material clamping cage	Polyamide
Material sealing gasket	Silicone
Temp. range min	-60 °C
Temp. range max	100 °C
Protection class	IP69, IP68 (5 bar 30 min)
Thread type	M
Ø Connection thread D	40
Lead	1,5
Length screw-in thread L	15 mm
Ø cable diameter min	16 mm
Ø cable diameter max	28 mm
Key width SW	46 mm
Collar diameter (E)	51 mm
Total length TL	51 mm - 62 mm
Type of cable anchorage	A
Install. torques fitting	20 N m
Install. torques cap nut	25 N m
Impact category	6
Surface	Nickel-plated
Order no. nickel-plated	10065813
Packing unit	10
Type	EMSKV-L 40 LT
ETIM-Classification	EC000441

Your Contact:

WISKA Hoppmann GmbH

Kisdorfer Weg 28 · 24568 Kaltenkirchen · Germany

☎ +49-4191-508-0 · 📠 +49-4191-508-209

contact@wiska.de · www.wiska.com

Recommended accessories

EMMU 40	10063146
RDE 40 LT	10063960
BS 28	10064016

20.11.2018

Your Contact:

WISKA Hoppmann GmbH

Kisdorfer Weg 28 · 24568 Kaltenkirchen · Germany

☎ +49-4191-508-0 · 📠 +49-4191-508-209

contact@wiska.de · www.wiska.com



Your Contact:

WISKA Hoppmann GmbH

Kisdorfer Weg 28 · 24568 Kaltenkirchen · Germany

☎ +49-4191-508-0 · 📠 +49-4191-508-209

contact@wiska.de · www.wiska.com