

## EMSKVZ-L 50

Cable gland long, brass nickel-plated, M50, with external strain relief

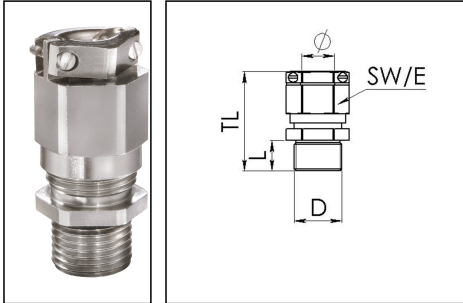

Product illustrations are exemplary and may differ from the chosen product. Further variants and individual customization, we will gladly provide you on request.



Material cable gland	Brass nickel-plated
Material clamping cage	Polyamide
Material sealing gasket	EPDM
Temp. range min	-40 °C
Temp. range max	100 °C
Protection class	IP69, IP68 (5 bar 30 min)
Thread type	M
Ø Connection thread D	50
Lead	1,5
Length screw-in thread L	15 mm
Ø cable diameter min	21 mm
Ø cable diameter max	35 mm
Ø cable diameter UL	24,3 mm - 33,4 mm
Key width SW	55 mm
Collar diameter (E)	61 mm
Total length TL	69 mm - 80 mm
Type of cable anchorage	B
Install. torques fitting	30 N m
Install. torques cap nut	30 N m
Impact category	6
Torque clamp srew	0,6 N m
Surface	Nickel-plated
Order no. nickel-plated	10065865
Packing unit	5
Type	EMSKVZ-L 50

Your Contact:

WISKA Hoppmann GmbH

Kisdorfer Weg 28 · 24568 Kaltenkirchen · Germany

☎ +49-4191-508-0 · 📠 +49-4191-508-209

contact@wiska.de · www.wiska.com

Recommended accessories

<b>RDE 50</b>	10062188
<b>EMMU 50</b>	10063147
<b>BS 35</b>	10064017

16.11.2018

Your Contact:

**WISKA Hoppmann GmbH**

Kisdorfer Weg 28 · 24568 Kaltenkirchen · Germany

☎ +49-4191-508-0 · 📠 +49-4191-508-209

contact@wiska.de · www.wiska.com

