

SKV 16

Cable gland, polyamide, Pg 16 RAL 7001

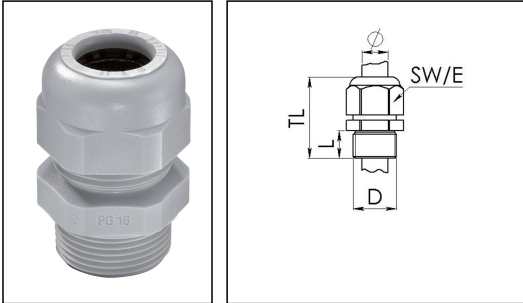

Product illustrations are exemplary and may differ from the chosen product. Further variants and individual customization, we will gladly provide you on request.

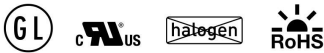

Material cable gland	Polyamide
Material sealing gasket	EPDM
Temp. range min	-40 °C
Temp. range max	100 °C
Protection class	IP68 (5 bar 30 min)
Thread type	PG
Ø Connection thread D	16
Length screw-in thread L	11 mm
Ø cable diameter min	8 mm
Ø cable diameter max	14 mm
Key width SW	27 mm
Collar diameter (E)	29 mm
Total length TL	38 mm - 44 mm
Glow wire test	750 °C
Type of cable anchorage	A
Product Color	RAL 7001
Order no. RAL 7001	10066005
Type	SKV 16
Packing unit	50
ETIM-Classification	EC000441

Recommended accessories

ADR 16	10061423
---------------	----------

Your Contact:

WISKA Hoppmann GmbH
Kisdorfer Weg 28 · 24568 Kaltenkirchen · Germany
☎ +49-4191-508-0 · 📠 +49-4191-508-209
contact@wiska.de · www.wiska.com

20.11.2018

Your Contact:

WISKA Hoppmann GmbH

Kisdorfer Weg 28 · 24568 Kaltenkirchen · Germany

☎ +49-4191-508-0 · 📠 +49-4191-508-209

contact@wiska.de · www.wiska.com



Your Contact:

WISKA Hoppmann GmbH

Kisdorfer Weg 28 · 24568 Kaltenkirchen · Germany

☎ +49-4191-508-0 · 📠 +49-4191-508-209

contact@wiska.de · www.wiska.com