

SKV 21

Cable gland, polyamide, Pg 21 RAL 7001

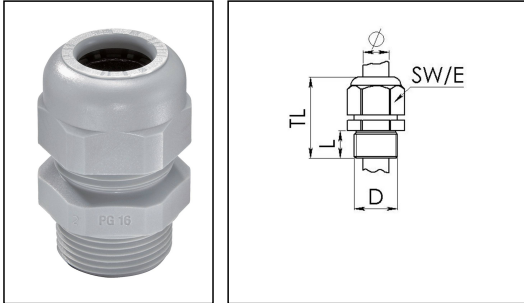

Product illustrations are exemplary and may differ from the chosen product. Further variants and individual customization, we will gladly provide you on request.



Material cable gland	Polyamide
Material sealing gasket	EPDM
Temp. range min	-40 °C
Temp. range max	100 °C
Protection class	IP68 (5 bar 30 min)
Thread type	PG
Ø Connection thread D	21
Length screw-in thread L	11 mm
Ø cable diameter min	10 mm
Ø cable diameter max	18 mm
Key width SW	33 mm
Collar diameter (E)	36 mm
Total length TL	43 mm - 50 mm
Glow wire test	750 °C
Type of cable anchorage	A
Product Color	RAL 7001
Order no. RAL 7001	10066006
Type	SKV 21
Packing unit	25
ETIM-Classification	EC000441

Recommended accessories

ADR 21	10061424
---------------	----------

Your Contact:

WISKA Hoppmann GmbH
Kisdorfer Weg 28 · 24568 Kaltenkirchen · Germany
☎ +49-4191-508-0 · 📠 +49-4191-508-209
contact@wiska.de · www.wiska.com

21.09.2018

Your Contact:

WISKA Hoppmann GmbH

Kisdorfer Weg 28 · 24568 Kaltenkirchen · Germany

☎ +49-4191-508-0 · 📠 +49-4191-508-209

contact@wiska.de · www.wiska.com



Your Contact:

WISKA Hoppmann GmbH

Kisdorfer Weg 28 · 24568 Kaltenkirchen · Germany

☎ +49-4191-508-0 · 📠 +49-4191-508-209

contact@wiska.de · www.wiska.com