

SKV 42

Cable gland, polyamide, Pg 42 RAL 7001

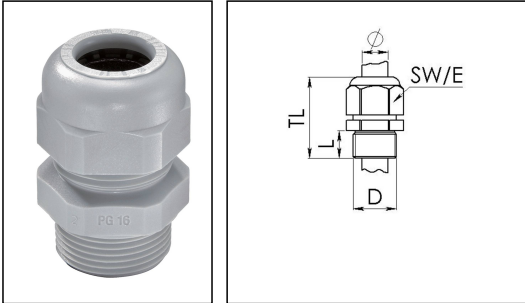

Product illustrations are exemplary and may differ from the chosen product. Further variants and individual customization, we will gladly provide you on request.

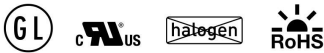

Material cable gland	Polyamide
Material sealing gasket	EPDM
Temp. range min	-40 °C
Temp. range max	100 °C
Protection class	IP68 (5 bar 30 min)
Thread type	PG
Ø Connection thread D	42
Length screw-in thread L	14 mm
Ø cable diameter min	28 mm
Ø cable diameter max	38 mm
Key width SW	60 mm
Collar diameter (E)	67 mm
Total length TL	58 mm - 67 mm
Glow wire test	750 °C
Type of cable anchorage	A
Product Color	RAL 7001
Order no. RAL 7001	10066009
Type	SKV 42
Packing unit	5
ETIM-Classification	EC000441

Recommended accessories

ADR 42	10061427
---------------	----------

Your Contact:



WISKA Hoppmann GmbH
Kisdorfer Weg 28 · 24568 Kaltenkirchen · Germany
☎ +49-4191-508-0 · 📠 +49-4191-508-209
contact@wiska.de · www.wiska.com

17.08.2018

Your Contact:

WISKA Hoppmann GmbH

Kisdorfer Weg 28 · 24568 Kaltenkirchen · Germany

 +49-4191-508-0 ·  +49-4191-508-209

contact@wiska.de · www.wiska.com



Your Contact:

WISKA Hoppmann GmbH

Kisdorfer Weg 28 · 24568 Kaltenkirchen · Germany

☎ +49-4191-508-0 · 📠 +49-4191-508-209

contact@wiska.de · www.wiska.com