

SKV 36

Cable gland, polyamide, Pg 36, RAL 9005

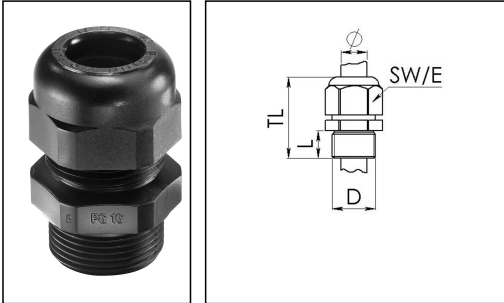

Product illustrations are exemplary and may differ from the chosen product. Further variants and individual customization, we will gladly provide you on request.

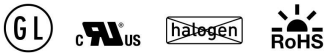

Material cable gland	Polyamide
Material sealing gasket	EPDM
Temp. range min	-40 °C
Temp. range max	100 °C
Protection class	IP68 (5 bar 30 min)
Thread type	PG
Ø Connection thread D	36
Length screw-in thread L	14 mm
Ø cable diameter min	22 mm
Ø cable diameter max	32 mm
Key width SW	53 mm
Collar diameter (E)	59 mm
Total length TL	56 mm - 65 mm
Glow wire test	750 °C
Type of cable anchorage	A
Product Color	RAL 9005
Order no. RAL 9005	10066198
Type	SKV 36
Packing unit	10
ETIM-Classification	EC000441

Recommended accessories

MUG 36	10060687
---------------	----------

Your Contact:

WISKA Hoppmann GmbH
Kisdorfer Weg 28 · 24568 Kaltenkirchen · Germany
☎ +49-4191-508-0 · 📠 +49-4191-508-209
contact@wiska.de · www.wiska.com

ADR 36

10061426

BS 28

10064016

18.08.2018

Your Contact:

WISKA Hoppmann GmbH

Kisdorfer Weg 28 · 24568 Kaltenkirchen · Germany

☎ +49-4191-508-0 · 📠 +49-4191-508-209

contact@wiska.de · www.wiska.com



Your Contact:

WISKA Hoppmann GmbH

Kisdorfer Weg 28 · 24568 Kaltenkirchen · Germany

☎ +49-4191-508-0 · 📠 +49-4191-508-209

contact@wiska.de · www.wiska.com