

SKV 11

Cable gland, polyamide, Pg 11, RAL 7035

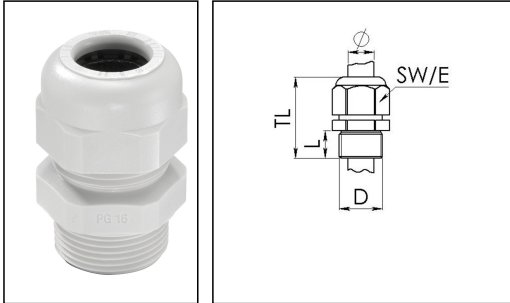

Product illustrations are exemplary and may differ from the chosen product. Further variants and individual customization, we will gladly provide you on request.

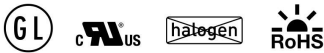

Material cable gland	Polyamide
Material sealing gasket	EPDM
Temp. range min	-40 °C
Temp. range max	100 °C
Protection class	IP68 (5 bar 30 min)
Thread type	PG
Ø Connection thread D	11
Length screw-in thread L	9 mm
Ø cable diameter min	5 mm
Ø cable diameter max	10 mm
Key width SW	22 mm
Collar diameter (E)	24 mm
Total length TL	33 mm - 39 mm
Glow wire test	750 °C
Type of cable anchorage	A
Product Color	RAL 7035
Order no. RAL 7035	10066402
Type	SKV 11
Packing unit	50
ETIM-Classification	EC000441

Recommended accessories

MUG 11	10060672
---------------	----------

Your Contact:

WISKA Hoppmann GmbH
Kisdorfer Weg 28 · 24568 Kaltenkirchen · Germany
☎ +49-4191-508-0 · 📠 +49-4191-508-209
contact@wiska.de · www.wiska.com

ADR 11

10061421

BS 10

10064008

17.11.2018

Your Contact:

WISKA Hoppmann GmbH

Kisdorfer Weg 28 · 24568 Kaltenkirchen · Germany

☎ +49-4191-508-0 · 📠 +49-4191-508-209

contact@wiska.de · www.wiska.com



Your Contact:

WISKA Hoppmann GmbH

Kisdorfer Weg 28 · 24568 Kaltenkirchen · Germany

☎ +49-4191-508-0 · 📠 +49-4191-508-209

contact@wiska.de · www.wiska.com