

## SKV 21

Cable gland, polyamide, Pg 21, RAL 7035

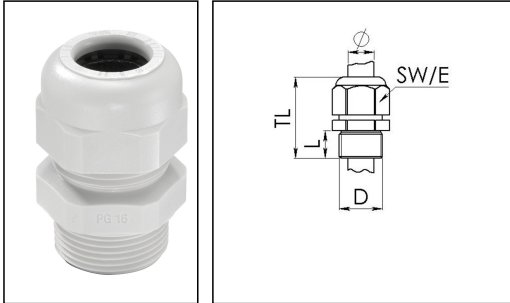

Product illustrations are exemplary and may differ from the chosen product. Further variants and individual customization, we will gladly provide you on request.



<b>Material cable gland</b>	Polyamide
<b>Material sealing gasket</b>	EPDM
<b>Temp. range min</b>	-40 °C
<b>Temp. range max</b>	100 °C
<b>Protection class</b>	IP68 (5 bar 30 min)
<b>Thread type</b>	PG
<b>Ø Connection thread D</b>	21
<b>Length screw-in thread L</b>	11 mm
<b>Ø cable diameter min</b>	10 mm
<b>Ø cable diameter max</b>	18 mm
<b>Key width SW</b>	33 mm
<b>Collar diameter (E)</b>	36 mm
<b>Total length TL</b>	43 mm - 50 mm
<b>Glow wire test</b>	750 °C
<b>Type of cable anchorage</b>	A
<b>Product Color</b>	RAL 7035
<b>Order no. RAL 7035</b>	10066405
<b>Type</b>	SKV 21
<b>Packing unit</b>	25
<b>ETIM-Classification</b>	EC000441

Recommended accessories

<b>MUG 21</b>	10060675
---------------	----------

Your Contact:

**WISKA Hoppmann GmbH**  
Kisdorfer Weg 28 · 24568 Kaltenkirchen · Germany  
☎ +49-4191-508-0 · 📠 +49-4191-508-209  
contact@wiska.de · www.wiska.com

ADR 21

10061424

**BS 17**

10064012

17.11.2018

Your Contact:

**WISKA Hoppmann GmbH**

Kisdorfer Weg 28 · 24568 Kaltenkirchen · Germany

☎ +49-4191-508-0 · 📠 +49-4191-508-209

contact@wiska.de · www.wiska.com



Your Contact:

**WISKA Hoppmann GmbH**

Kisdorfer Weg 28 · 24568 Kaltenkirchen · Germany

☎ +49-4191-508-0 · 📠 +49-4191-508-209

contact@wiska.de · www.wiska.com