

SKV 48

Cable gland, polyamide, Pg 48, RAL 7035

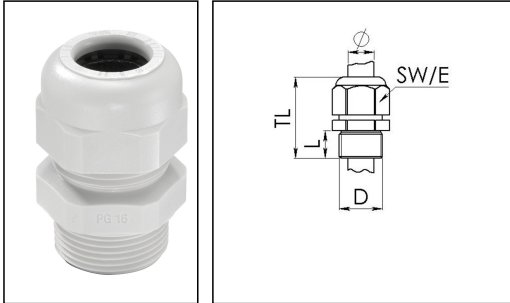

Product illustrations are exemplary and may differ from the chosen product. Further variants and individual customization, we will gladly provide you on request.



Material cable gland	Polyamide
Material sealing gasket	EPDM
Temp. range min	-40 °C
Temp. range max	100 °C
Protection class	IP68 (5 bar 30 min)
Thread type	PG
Ø Connection thread D	48
Length screw-in thread L	15 mm
Ø cable diameter min	36 mm
Ø cable diameter max	44 mm
Key width SW	65 mm
Collar diameter (E)	73 mm
Total length TL	60 mm - 68 mm
Glow wire test	750 °C
Type of cable anchorage	A
Product Color	RAL 7035
Order no. RAL 7035	10066409
Type	SKV 48
Packing unit	4
ETIM-Classification	EC000441

Recommended accessories

MUG 48	10060679
---------------	----------

Your Contact:

WISKA Hoppmann GmbH

Kisdorfer Weg 28 · 24568 Kaltenkirchen · Germany

☎ +49-4191-508-0 · 📠 +49-4191-508-209

contact@wiska.de · www.wiska.com

ADR 48

10061428

BS 38

10064018

16.11.2018

Your Contact:

WISKA Hoppmann GmbH

Kisdorfer Weg 28 · 24568 Kaltenkirchen · Germany

☎ +49-4191-508-0 · 📠 +49-4191-508-209

contact@wiska.de · www.wiska.com



Your Contact:

WISKA Hoppmann GmbH

Kisdorfer Weg 28 · 24568 Kaltenkirchen · Germany

☎ +49-4191-508-0 · 📠 +49-4191-508-209

contact@wiska.de · www.wiska.com