

## PMSKV 9-16

Cable gland, brass nickel-plated, Pg 9

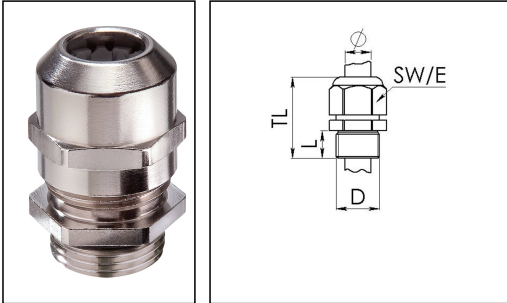

Product illustrations are exemplary and may differ from the chosen product. Further variants and individual customization, we will gladly provide you on request.



Material cable gland	Brass nickel-plated
Material clamping cage	Polyamide
Material sealing gasket	EPDM
Temp. range min	-40 °C
Temp. range max	100 °C
Protection class	IP69, IP68 (5 bar 30 min)
Thread type	PG
Ø Connection thread D	9
Length screw-in thread L	5 mm
Ø cable diameter min	4,5 mm
Ø cable diameter max	10 mm
Key width SW	20 mm
Collar diameter (E)	22 mm
Total length TL	26 mm - 34 mm
Type of cable anchorage	A
Install. torques fitting	4 N m
Install. torques cap nut	7,5 N m
Impact category	6
Surface	Nickel-plated
Order no. nickel-plated	10100490
Type	PMSKV 9-16
Packing unit	50
ETIM-Classification	EC000441

Your Contact:

WISKA Hoppmann GmbH

Kisdorfer Weg 28 · 24568 Kaltenkirchen · Germany

☎ +49-4191-508-0 · 📠 +49-4191-508-209

contact@wiska.de · www.wiska.com

## Recommended accessories

<b>MMU 9</b>	10062142
<b>BS 10</b>	10064008
<b>MFD 16/02/040</b>	10064393
<b>MFD 16/03/021</b>	10101014

15.08.2018

## Your Contact:

**WISKA Hoppmann GmbH**

Kisdorfer Weg 28 · 24568 Kaltenkirchen · Germany

☎ +49-4191-508-0 · 📠 +49-4191-508-209

contact@wiska.de · www.wiska.com



Your Contact:

**WISKA Hoppmann GmbH**

Kisdorfer Weg 28 · 24568 Kaltenkirchen · Germany

☎ +49-4191-508-0 · 📠 +49-4191-508-209

contact@wiska.de · www.wiska.com