

PMSKV 16-20

Cable gland, brass nickel-plated, Pg 16

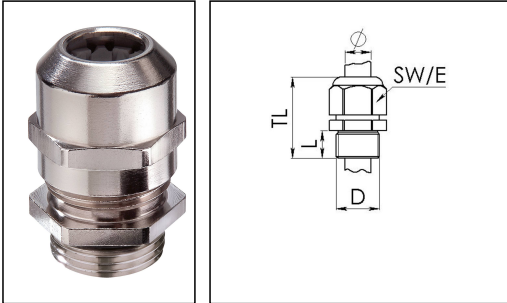

Product illustrations are exemplary and may differ from the chosen product. Further variants and individual customization, we will gladly provide you on request.



Material cable gland	Brass nickel-plated
Material clamping cage	Polyamide
Material sealing gasket	EPDM
Temp. range min	-40 °C
Temp. range max	100 °C
Protection class	IP69, IP68 (5 bar 30 min)
Thread type	PG
Ø Connection thread D	16
Length screw-in thread L	6 mm
Ø cable diameter min	6 mm
Ø cable diameter max	13 mm
Key width SW	29 mm
Collar diameter (E)	27 mm
Total length TL	28 mm - 36 mm
Type of cable anchorage	A
Install. torques fitting	8 N m
Install. torques cap nut	10 N m
Impact category	6
Surface	Nickel-plated
Order no. nickel-plated	10100686
Type	PMSKV 16-20
Packing unit	50
ETIM-Classification	EC000441

Your Contact:

WISKA Hoppmann GmbH

Kisdorfer Weg 28 · 24568 Kaltenkirchen · Germany

☎ +49-4191-508-0 · 📠 +49-4191-508-209

contact@wiska.de · www.wiska.com

Recommended accessories

MFD 20/02/065	10060953
MMU 16	10062145
BS 13	10064010
MFD 20/03/040	10064341
MFD 20/02/060	10064395
MFD 20/02/050	10101015
MFD 20/03/045	10102306

18.08.2018

Your Contact:

WISKA Hoppmann GmbH

Kisdorfer Weg 28 · 24568 Kaltenkirchen · Germany

☎ +49-4191-508-0 · 📠 +49-4191-508-209

contact@wiska.de · www.wiska.com



Your Contact:

WISKA Hoppmann GmbH

Kisdorfer Weg 28 · 24568 Kaltenkirchen · Germany

☎ +49-4191-508-0 · 📠 +49-4191-508-209

contact@wiska.de · www.wiska.com