

PMSKV 21-25

Cable gland, brass nickel-plated, Pg 21

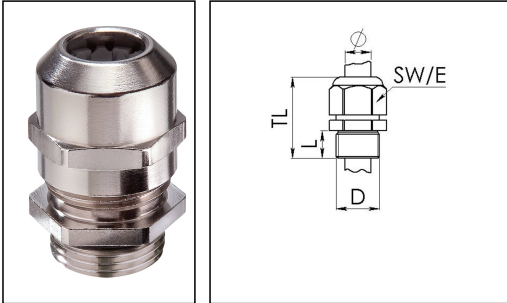

Product illustrations are exemplary and may differ from the chosen product. Further variants and individual customization, we will gladly provide you on request.



Material cable gland	Brass nickel-plated
Material clamping cage	Polyamide
Material sealing gasket	EPDM
Temp. range min	-40 °C
Temp. range max	100 °C
Protection class	IP69, IP68 (5 bar 30 min)
Thread type	PG
Ø Connection thread D	21
Length screw-in thread L	7 mm
Ø cable diameter min	9 mm
Ø cable diameter max	17 mm
Key width SW	36 mm
Collar diameter (E)	40 mm
Total length TL	33 mm - 42 mm
Type of cable anchorage	A
Install. torques fitting	10 N m
Install. torques cap nut	15 N m
Impact category	6
Surface	Nickel-plated
Order no. nickel-plated	10100688
Type	PMSKV 21-25
Packing unit	50
ETIM-Classification	EC000441

Your Contact:

WISKA Hoppmann GmbH

Kisdorfer Weg 28 · 24568 Kaltenkirchen · Germany

☎ +49-4191-508-0 · 📠 +49-4191-508-209

contact@wiska.de · www.wiska.com

Recommended accessories

MFD 25/02/060	10060452
MFD 25/02/080	10060952
MFD 25/01/065	10060954
MMU 21	10062146
MFD 25/02/070	10063995
BS 17	10064012
MFD 25/03/070	10064342
MFD 25/04/060	10064343
MFD 25/01/090	10101016
MFD 25/01/105-01/055	10101255
MFD 25/05/056	10102023

17.11.2018

Your Contact:

WISKA Hoppmann GmbH

Kisdorfer Weg 28 · 24568 Kaltenkirchen · Germany

☎ +49-4191-508-0 · 📠 +49-4191-508-209

contact@wiska.de · www.wiska.com



Your Contact:

WISKA Hoppmann GmbH

Kisdorfer Weg 28 · 24568 Kaltenkirchen · Germany

☎ +49-4191-508-0 · 📠 +49-4191-508-209

contact@wiska.de · www.wiska.com