

HGSM 50-E pack

Cable gland, stainless steel, M50

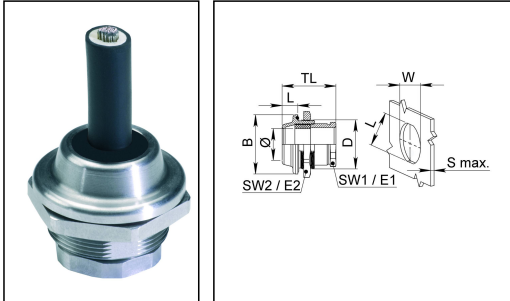

Product illustrations are exemplary and may differ from the chosen product. Further variants and individual customization, we will gladly provide you on request.



Material cable gland	Stainless steel A2 (1.4305)
Material sealing gasket	EPDM
Temp. range min	-40 °C
Temp. range max	120 °C
Protection class	IP68 (5 bar 30 min), IP69
Thread type	M
Ø Connection thread D	50
Lead	1,5
Ø cable diameter min	26 mm
Ø cable diameter max	38 mm
Key width SW1	45 mm
Key width SW2	60 mm
Collar diameter E1	47 mm
Collar diameter E2	65 mm
LxWxS (max)	47x50x10mm
BxL	56x16mm
Total length TL	37 mm - 53 mm
Advice	Incl. sealing rings, locknut
WISKA-Order no.	10101859
Type	HGSM 50-E pack
Packing unit	1
ETIM-Classification	EC000441

18.08.2018

Your Contact:

WISKA Hoppmann GmbH

Kisdorfer Weg 28 · 24568 Kaltenkirchen · Germany

☎ +49-4191-508-0 · 📠 +49-4191-508-209

contact@wiska.de · www.wiska.com

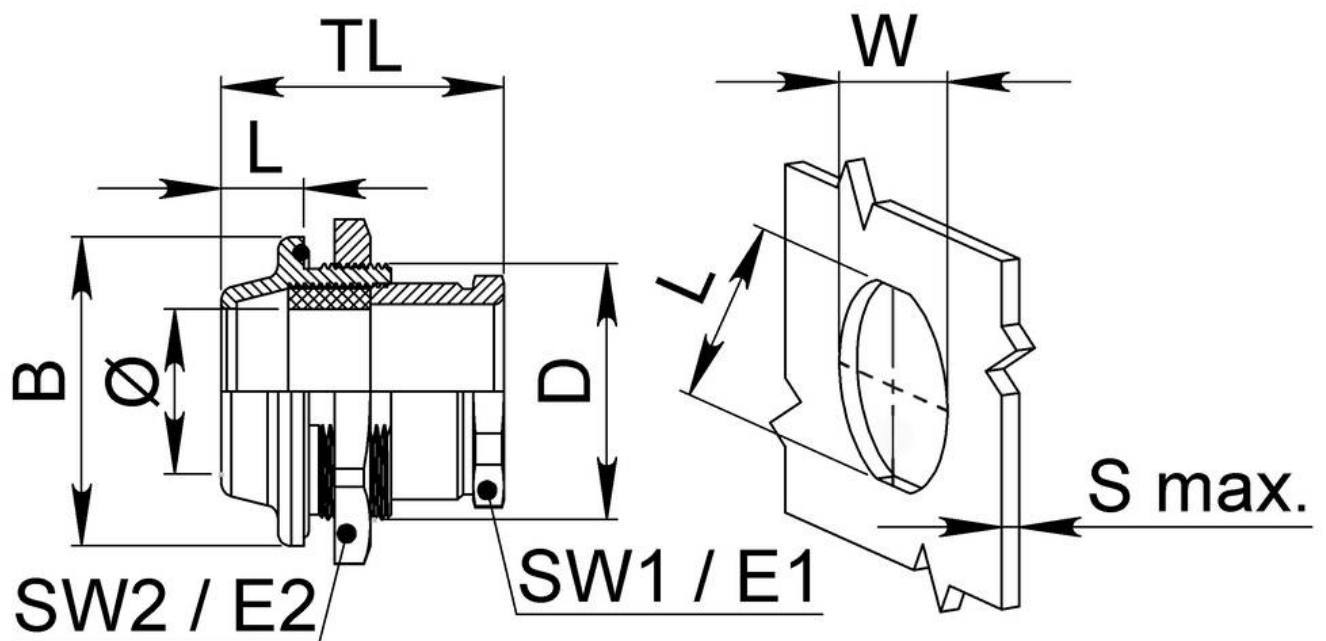

Your Contact:

WISKA Hoppmann GmbH

Kisdorfer Weg 28 · 24568 Kaltenkirchen · Germany

☎ +49-4191-508-0 · 📠 +49-4191-508-209

contact@wiska.de · www.wiska.com