

HGSM 63-LT pack

Cable gland, stainless steel, M63

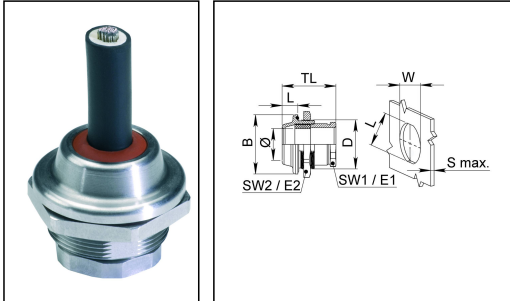

Product illustrations are exemplary and may differ from the chosen product. Further variants and individual customization, we will gladly provide you on request.



Material cable gland	Stainless steel A2 (1.4305)
Material sealing gasket	Silicone
Temp. range min	-60 °C
Temp. range max	180 °C
Protection class	IP69, IP68 (5 bar 30 min)
Thread type	M
Ø Connection thread D	63
Lead	1,5
Ø cable diameter min	32 mm
Ø cable diameter max	49 mm
Key width SW1	56 mm
Key width SW2	70 mm
Collar diameter E1	60 mm
Collar diameter E2	75 mm
LxWxS (max)	59x63x10mm
BxL	70x18mm
Total length TL	42 mm - 60 mm
Advice	Incl. sealing rings, locknut
WISKA-Order no.	10102123
Type	HGSM 63-LT pack
Packing unit	1

17.11.2018

Your Contact:

WISKA Hoppmann GmbH

Kisdorfer Weg 28 · 24568 Kaltenkirchen · Germany

☎ +49-4191-508-0 · 📠 +49-4191-508-209

contact@wiska.de · www.wiska.com



Your Contact:

WISKA Hoppmann GmbH

Kisdorfer Weg 28 · 24568 Kaltenkirchen · Germany

☎ +49-4191-508-0 · 📠 +49-4191-508-209

contact@wiska.de · www.wiska.com