

EMKV 50

Cable gland, brass nickel-plated, M50

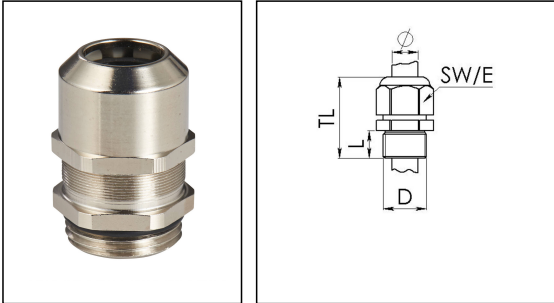

Product illustrations are exemplary and may differ from the chosen product. Further variants and individual customization, we will gladly provide you on request.



Material cable gland	Brass nickel-plated
Material clamping cage	Polyamide
Material sealing gasket	EPDM
Temp. range min	-40 °C
Temp. range max	100 °C
Protection class	IP68 (5 bar 30 min)
Thread type	M
Ø Connection thread D	50
Lead	1,5
Length screw-in thread L	9 mm
Ø cable diameter min	21 mm
Ø cable diameter max	35 mm
Key width SW	54 mm
Collar diameter (E)	60 mm
Type of cable anchorage	A
Total length TL	51 mm - 58 mm
Install. torques fitting	30 N m
Install. torques cap nut	30 N m
Impact category	6
Surface	Nickel-plated
Order no. nickel-plated	10103087
Type	EMKV 50
Packing unit	10

Your Contact:

WISKA Hoppmann GmbH

Kisdorfer Weg 28 · 24568 Kaltenkirchen · Germany

☎ +49-4191-508-0 · 📠 +49-4191-508-209

contact@wiska.de · www.wiska.com

Recommended accessories

BS 35

10064017

16.08.2018

Your Contact:

WISKA Hoppmann GmbH

Kisdorfer Weg 28 · 24568 Kaltenkirchen · Germany

☎ +49-4191-508-0 · 📠 +49-4191-508-209

contact@wiska.de · www.wiska.com



Your Contact:

WISKA Hoppmann GmbH

Kisdorfer Weg 28 · 24568 Kaltenkirchen · Germany

☎ +49-4191-508-0 · 📠 +49-4191-508-209

contact@wiska.de · www.wiska.com