

HGSM 40 FD pack

Cable gland, stainless steel, M40

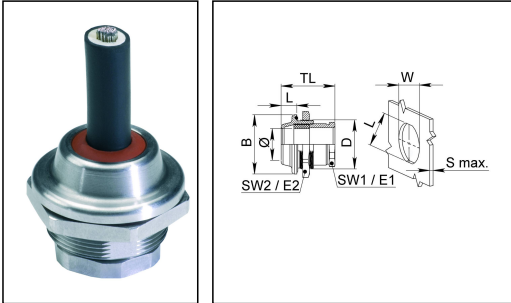

Product illustrations are exemplary and may differ from the chosen product. Further variants and individual customization, we will gladly provide you on request.



Material cable gland	Stainless steel A2 (1.4305)
Material sealing gasket	Silicone
Temp. range min	-60 °C
Temp. range max	180 °C
Protection class	IP68 (5 bar 30 min), IP69
Thread type	M
Ø Connection thread D	40
Lead	1,5
Ø cable diameter min	16 mm
Ø cable diameter max	29 mm
Key width SW1	35 mm
Key width SW2	46 mm
Collar diameter E1	37 mm
Collar diameter E2	50 mm
LxWxS (max)	37x40x10mm
BxL	46x14mm
Total length TL	33 mm - 47 mm
Advice	Incl. sealing rings, locknut
WISKA-Order no.	10103628
Type	HGSM 40 FD pack
Packing unit	1

16.11.2018

Your Contact:

WISKA Hoppmann GmbH

Kisdorfer Weg 28 · 24568 Kaltenkirchen · Germany

☎ +49-4191-508-0 · 📠 +49-4191-508-209

contact@wiska.de · www.wiska.com

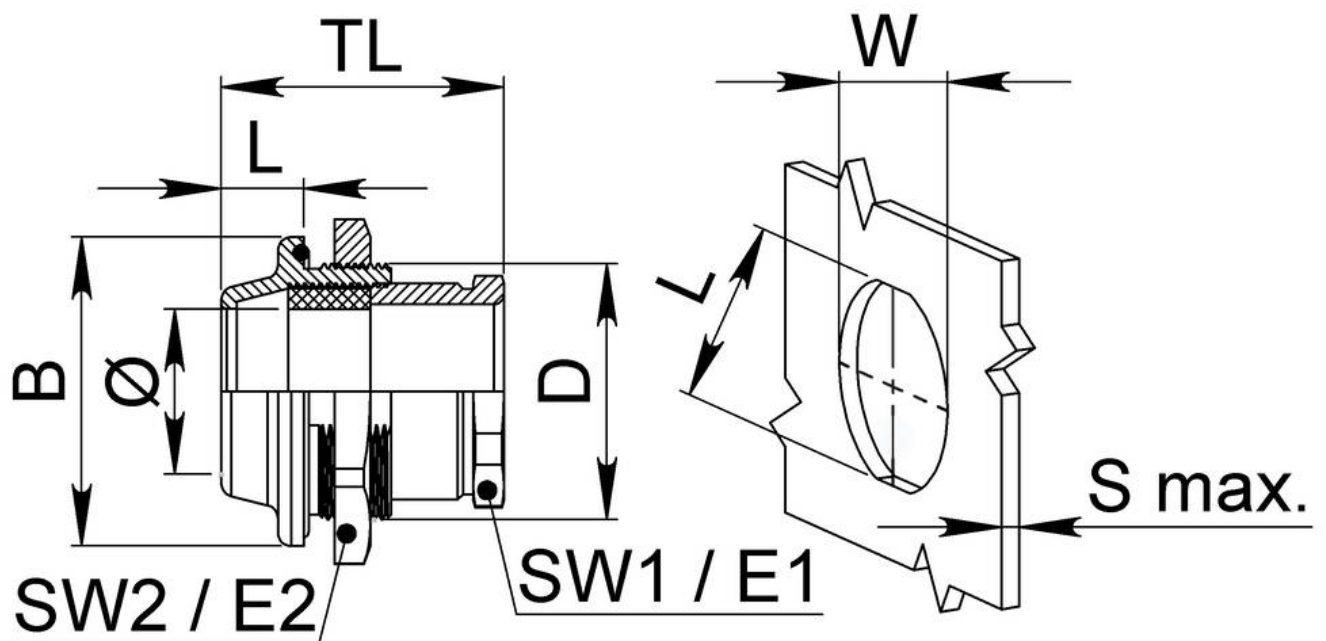

Your Contact:

WISKA Hoppmann GmbH

Kisdorfer Weg 28 · 24568 Kaltenkirchen · Germany

☎ +49-4191-508-0 · 📠 +49-4191-508-209

contact@wiska.de · www.wiska.com