

## HGSM 63 FD pack

Cable gland, stainless steel, M63

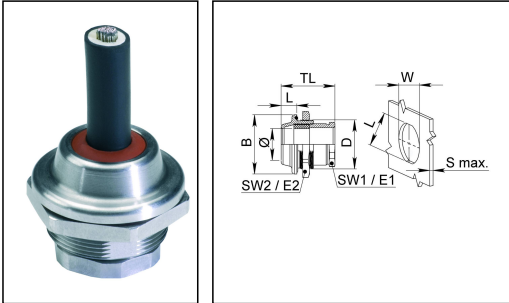

Product illustrations are exemplary and may differ from the chosen product. Further variants and individual customization, we will gladly provide you on request.



<b>Material cable gland</b>	Stainless steel A2 (1.4305)
<b>Material sealing gasket</b>	Silicone
<b>Temp. range min</b>	-60 °C
<b>Temp. range max</b>	180 °C
<b>Protection class</b>	IP68 (5 bar 30 min), IP69
<b>Thread type</b>	M
<b>Ø Connection thread D</b>	63
<b>Lead</b>	1,5
<b>Ø cable diameter min</b>	32 mm
<b>Ø cable diameter max</b>	49 mm
<b>Key width SW1</b>	56 mm
<b>Key width SW2</b>	70 mm
<b>Collar diameter E1</b>	60 mm
<b>Collar diameter E2</b>	75 mm
<b>LxWxS (max)</b>	59x63x10mm
<b>BxL</b>	70x18mm
<b>Total length TL</b>	42 mm - 60 mm
<b>Advice</b>	Incl. sealing rings, locknut
<b>WISKA-Order no.</b>	10103630
<b>Type</b>	HGSM 63 FD pack
<b>Packing unit</b>	1

17.11.2018

Your Contact:

**WISKA Hoppmann GmbH**

Kisdorfer Weg 28 · 24568 Kaltenkirchen · Germany

☎ +49-4191-508-0 · 📠 +49-4191-508-209

contact@wiska.de · www.wiska.com

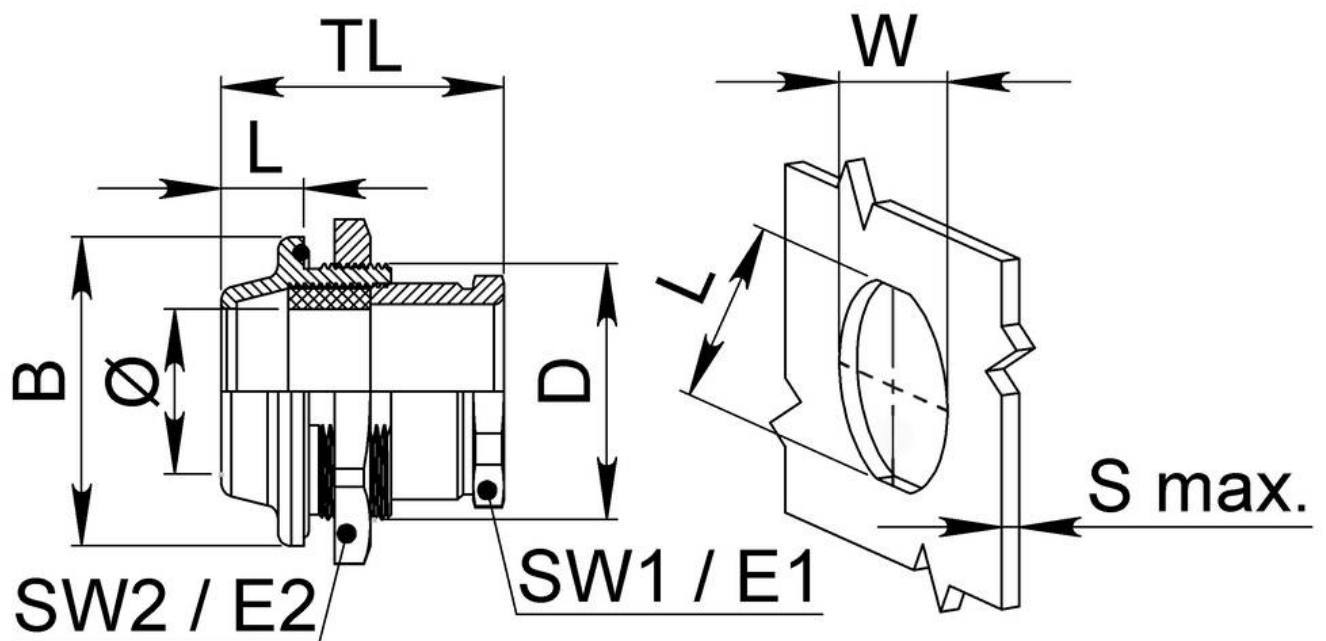

Your Contact:

**WISKA Hoppmann GmbH**

Kisdorfer Weg 28 · 24568 Kaltenkirchen · Germany

☎ +49-4191-508-0 · 📠 +49-4191-508-209

contact@wiska.de · www.wiska.com